

# Getting Started Guide

---



Version 7.0



## Revision History

DATE	VERSION	REVISION
08/06/2012	1.0	Initial Release
08/08/2012	2.0	Further clarified un-mounting of media
08/10/2012	3.0	Further clarified Processing System and Programmable Logic in diagrams. Provided other needed edits identified by ZedBoard.org forum users.
08/11/2012	4.0	Further clarified host PC requirements. Added Appendix for showing how to connect with Linux host PC.
08/14/2012	5.0	Updated Hardware Block Diagram.
09/04/2012	6.0	Updated Hardware Block Diagram.
01/30/2014	7.0	Updated Links and Cypress USB-UART installation instructions

# AVNET DESIGN KIT TECHNICAL SUPPORT FILES AND DOWNLOADS WEB ACCESS INSTRUCTIONS

Thank you for purchasing an Avnet design kit. The technical support documents associated with this kit, including the User Guide, Bill of Materials, Schematics, Source Code and Application Notes, are available online. You, the Customer, can access these documents at any time by visiting the ZedBoard Community Web Site at: [www.zedboard.org](http://www.zedboard.org)

## LICENSE AGREEMENT

THE AVNET DESIGN KIT (“DESIGN KIT” OR “PRODUCT”) AND ANY SUPPORTING DOCUMENTATION (“DOCUMENTATION” OR “PRODUCT DOCUMENTATION”) IS SUBJECT TO THIS LICENSE AGREEMENT (“LICENSE”). USE OF THE PRODUCT OR DOCUMENTATION SIGNIFIES ACCEPTANCE OF THE TERMS AND CONDITIONS OF THIS LICENSE. THE TERMS OF THIS LICENSE AGREEMENT ARE IN ADDITION TO THE AVNET CUSTOMER TERMS AND CONDITIONS, WHICH CAN BE VIEWED AT [www.em.avnet.com](http://www.em.avnet.com). THE TERMS OF THIS LICENSE AGREEMENT WILL CONTROL IN THE EVENT OF A CONFLICT.

1. **Limited License.** Avnet grants You, the Customer, (“You” “Your” or “Customer”) a limited, non-exclusive, non-transferable, license to: (a) use the Product for Your own internal testing, evaluation and design efforts at a single Customer site; (b) create a single derivative work based on the Product using the same semiconductor supplier product or product family as used in the Product; and (c) make, use and sell the Product in a single production unit. No other rights are granted and Avnet and any other Product licensor reserves all rights not specifically granted in this License Agreement. Except as expressly permitted in this License, neither the Design Kit, Documentation, nor any portion may be reverse engineered, disassembled, decompiled, sold, donated, shared, leased, assigned, sublicensed or otherwise transferred by Customer. The term of this License is in effect until terminated. Customer may terminate this license at any time by destroying the Product and all copies of the Product Documentation.
2. **Changes.** Avnet may make changes to the Product or Product Documentation at any time without notice. Avnet makes no commitment to update or upgrade the Product or Product Documentation and Avnet reserves the right to discontinue the Product or Product Documentation at any time without notice.
3. **Limited Warranty.** ALL PRODUCTS AND DOCUMENTATION ARE PROVIDED “AS IS” WITHOUT WARRANTY OF ANY KIND. AVNET MAKES NO WARRANTIES, EITHER EXPRESS OR IMPLIED, WITH RESPECT TO THE PRODUCTS AND DOCUMENTATION PROVIDED HEREUNDER. AVNET SPECIFICALLY DISCLAIMS THE IMPLIED WARRANTIES OF MERCHANTABILITY AND FITNESS FOR A PARTICULAR PURPOSE AND ANY WARRANTY AGAINST INFRINGEMENT OF ANY INTELLECTUAL PROPERTY RIGHT OF ANY THIRD PARTY WITH REGARD TO THE PRODUCTS AND DOCUMENTATION.
4. **LIMITATIONS OF LIABILITY. CUSTOMER SHALL NOT BE ENTITLED TO AND AVNET WILL NOT BE LIABLE FOR ANY INDIRECT, SPECIAL, INCIDENTAL OR CONSEQUENTIAL DAMAGES OF ANY KIND OR NATURE, INCLUDING, WITHOUT LIMITATION, BUSINESS INTERRUPTION COSTS, LOSS OF PROFIT OR REVENUE, LOSS OF DATA, PROMOTIONAL OR MANUFACTURING EXPENSES, OVERHEAD, COSTS OR EXPENSES ASSOCIATED WITH WARRANTY OR INTELLECTUAL PROPERTY INFRINGEMENT CLAIMS, INJURY TO REPUTATION OR LOSS OF CUSTOMERS, EVEN IF AVNET HAS BEEN ADVISED OF THE POSSIBILITY OF SUCH DAMAGES. THE PRODUCTS AND DOCUMENTATION ARE NOT DESIGNED, AUTHORIZED OR WARRANTED TO BE SUITABLE FOR USE IN MEDICAL, MILITARY, AIR CRAFT, SPACE OR LIFE SUPPORT EQUIPMENT NOR IN APPLICATIONS WHERE FAILURE OR MALFUNCTION OF THE PRODUCTS CAN REASONABLY BE EXPECTED TO RESULT IN A PERSONAL INJURY, DEATH OR SEVERE PROPERTY OR ENVIRONMENTAL DAMAGE. INCLUSION OR USE OF PRODUCTS IN SUCH EQUIPMENT OR APPLICATIONS, WITHOUT PRIOR AUTHORIZATION IN WRITING OF AVNET, IS NOT PERMITTED AND IS AT CUSTOMER’S OWN RISK. CUSTOMER AGREES TO FULLY INDEMNIFY AVNET FOR ANY DAMAGES RESULTING FROM SUCH INCLUSION OR USE.**
5. **LIMITATION OF DAMAGES. CUSTOMER’S RECOVERY FROM AVNET FOR ANY CLAIM SHALL NOT EXCEED CUSTOMER’S PURCHASE PRICE FOR THE PRODUCT GIVING RISE TO SUCH CLAIM IRRESPECTIVE OF THE NATURE OF THE CLAIM, WHETHER IN CONTRACT, TORT, WARRANTY, OR OTHERWISE.**
6. **INDEMNIFICATION. AVNET SHALL NOT BE LIABLE FOR AND CUSTOMER SHALL INDEMNIFY, DEFEND AND HOLD AVNET HARMLESS FROM ANY CLAIMS BASED ON AVNET’S COMPLIANCE WITH CUSTOMER’S DESIGNS, SPECIFICATIONS OR INSTRUCTIONS, OR MODIFICATION OF ANY PRODUCT BY PARTIES OTHER THAN AVNET, OR USE IN COMBINATION WITH OTHER PRODUCTS.**
7. **U.S. Government Restricted Rights.** The Product and Product Documentation are provided with “RESTRICTED RIGHTS.” If the Product and Product Documentation and related technology or documentation are provided to or made available to the United States Government, any use, duplication, or disclosure by the United States Government is subject to restrictions applicable to proprietary commercial computer software as set forth in FAR 52.227-14 and DFAR 252.227-7013, et seq., its successor and other applicable laws and regulations. Use of the Product by the United States Government constitutes acknowledgment of the proprietary rights of Avnet and any third parties. No other governments are authorized to use the Product without written agreement of Avnet and applicable third parties.

8. Ownership. Licensee acknowledges and agrees that Avnet or Avnet's licensors are the sole and exclusive owner of all Intellectual Property Rights in the Licensed Materials, and Licensee shall acquire no right, title, or interest in the Licensed Materials, other than any rights expressly granted in this Agreement.
9. Intellectual Property. All trademarks, service marks, logos, slogans, domain names and trade names (collectively "Marks") are the properties of their respective owners. Avnet disclaims any proprietary interest in Marks other than its own. Avnet and AV design logos are registered trademarks and service marks of Avnet, Inc. Avnet's Marks may be used only with the prior written permission of Avnet, Inc.
10. General. The terms and conditions set forth in the License Agreement or at [www.em.avnet.com](http://www.em.avnet.com) will apply notwithstanding any conflicting, contrary or additional terms and conditions in any purchase order, sales acknowledgement confirmation or other document. If there is any conflict, the terms of this License Agreement will control. This License may not be assigned by Customer, by operation of law, merger or otherwise, without the prior written consent of Avnet and any attempted or purported assignment shall be void. Licensee understands that portions of the Licensed Materials may have been licensed to Avnet from third parties and that such third parties are intended beneficiaries of the provisions of this Agreement. In the event any of the provisions of this Agreement are for any reason determined to be void or unenforceable, the remaining provisions will remain in full effect. This constitutes the entire agreement between the parties with respect to the use of this Product, and supersedes all prior or contemporaneous understandings or agreements, written or oral, regarding such subject matter. No waiver or modification is effective unless agreed to in writing and signed by authorized representatives of both parties. The obligations, rights, terms and conditions shall be binding on the parties and their respective successors and assigns. The License Agreement is governed by and construed in accordance with the laws of the State of Arizona excluding any law or principle, which would apply the law of any other jurisdiction. The United Nations Convention for the International Sale of Goods shall not apply.

# TABLE OF CONTENTS

<b>Getting Started with ZedBoard .....</b>	<b>6</b>
Introduction.....	6
What's Inside the Box? .....	7
What's on the Web?.....	7
<b>Key Features .....</b>	<b>8</b>
ZedBoard Hardware Block Diagram .....	9
<b>ZedBoard Basic Setup and Operation .....</b>	<b>10</b>
Hardware Setup .....	11
Linux Startup and Shutdown .....	14
<b>Example Design Description .....</b>	<b>15</b>
ZedBoard Example Design System Block Diagram.....	15
<b>Demo 1 – Interacting with GPIO Switches and LEDs.....</b>	<b>16</b>
Purpose.....	16
Running the Demo on ZedBoard Hardware .....	16
<b>Demo 2 – OLED Display .....</b>	<b>18</b>
Purpose.....	18
Running the Demo on ZedBoard Hardware .....	18
<b>Demo 3 – VGA Display .....</b>	<b>20</b>
Purpose.....	20
Running the Demo on ZedBoard Hardware .....	20
<b>Demo 4 – HDMI Display .....</b>	<b>22</b>
Purpose.....	22
Running the Demo on ZedBoard Hardware .....	22
<b>Demo 5 – Ethernet .....</b>	<b>24</b>
Purpose.....	24
Host PC Networking Configuration .....	24
Running the Demo on ZedBoard Hardware .....	25
<b>Demo 6 – USB-OTG .....</b>	<b>29</b>
Purpose.....	29
Running the Demo on ZedBoard Hardware .....	29
<b>Demo 7 – SD Card.....</b>	<b>31</b>
Purpose.....	31
Running the Demo on ZedBoard Hardware .....	31
<b>What's Next.....</b>	<b>33</b>
<b>Where To Get More Information .....</b>	<b>33</b>
Xilinx Website .....	33
Cypress Website.....	33
<b>Getting Additional Help and Support .....</b>	<b>34</b>
Avnet Support.....	34
Xilinx Support .....	34
<b>Appendix I: Installing and Licensing Xilinx Software .....</b>	<b>35</b>
Install ISE WebPACK or Design Suite .....	35
<b>Appendix II: QSPI Flash Example Application .....</b>	<b>36</b>
Boot ZedBoard from QSPI.....	36
<b>Appendix III: Using Linux Host PC.....</b>	<b>37</b>
Connect Terminal to ZedBoard USB-UART .....	37
Connect Networking to ZedBoard .....	38

# GETTING STARTED WITH ZEDBOARD

The ZedBoard enables hardware and software developers to create or evaluate Zynq™-7000 All Programmable SoC designs.

The expandability features of this evaluation and development platform make it ideal for rapid prototyping and proof-of-concept development. The ZedBoard includes Xilinx XADC, FMC (FPGA Mezzanine Card), and Digilent Pmod™ compatible expansion headers as well as many common features used in system design. ZedBoard enables embedded computing capability by using DDR3 memory, Flash memory, gigabit Ethernet, general purpose I/O, and UART technologies.

This Getting Started Guide will outline the steps to setup the ZedBoard hardware. It documents the procedure to run a simple Linux design to show a Linux application running on the ARM® dual-core Cortex™-A9 MPCore™ Processing System (PS) and interacting with the tightly coupled 7 series 85K Programmable Logic (PL) cells. Xilinx Embedded Development tools are also introduced where the design can be built from scratch and customization options can be discovered. If Xilinx ISE WebPACK or Design Suite software is not already installed, further resources to install the software, get updated and generate a license are provided in Appendix I.

# WHAT'S INSIDE THE BOX?



## ZedBoard Kit contents:

- ZedBoard
- 12 volt / 5 ampere power supply with US, European AC adapter
- USB-A to Micro-USB-B cable
- Micro-USB-B to Type A Female adapter cable
- 4GB SD card
- Software
  - Xilinx Vivado DVD
  - Xilinx License Voucher for Vivado Design Edition tools for ZedBoard designs
- Documentation
  - Getting Started Card

# WHAT'S ON THE WEB?

ZedBoard is a community-oriented kit, with all materials being made available through the [ZedBoard.org](http://ZedBoard.org) community website.

## Official Documentation:

- Schematics
- Layout
- Hardware manual

## Tutorials and Reference Designs:

- Introductory material for beginners
- Design examples

# ZEDBOARD KEY FEATURES

- Processor
  - Zynq™-7000 AP SoC XC7Z020-CLG484-1
- Memory
  - 512 MB DDR3
  - 256 Mb Quad-SPI Flash
  - 4 GB SD card
- Communication
  - Onboard USB-JTAG Programming
  - 10/100/1000 Ethernet
  - USB OTG 2.0 and USB-UART
- Expansion connectors
  - FMC-LPC connector (68 single-ended or 34 differential I/Os)
  - 5 Pmod™ compatible headers (2x6)
  - Agile Mixed Signaling (AMS) header
- Clocking
  - 33.33333 MHz clock source for PS
  - 100 MHz oscillator for PL
- Display
  - HDMI output supporting 1080p60 with 16-bit, YCbCr, 4:2:2 mode color
  - VGA output (12-bit resolution color)
  - 128x32 OLED display
- Configuration and Debug
  - Onboard USB-JTAG interface
  - Xilinx Platform Cable JTAG connector
- General Purpose I/O
  - 8 user LEDs
  - 7 push buttons
  - 8 DIP switches



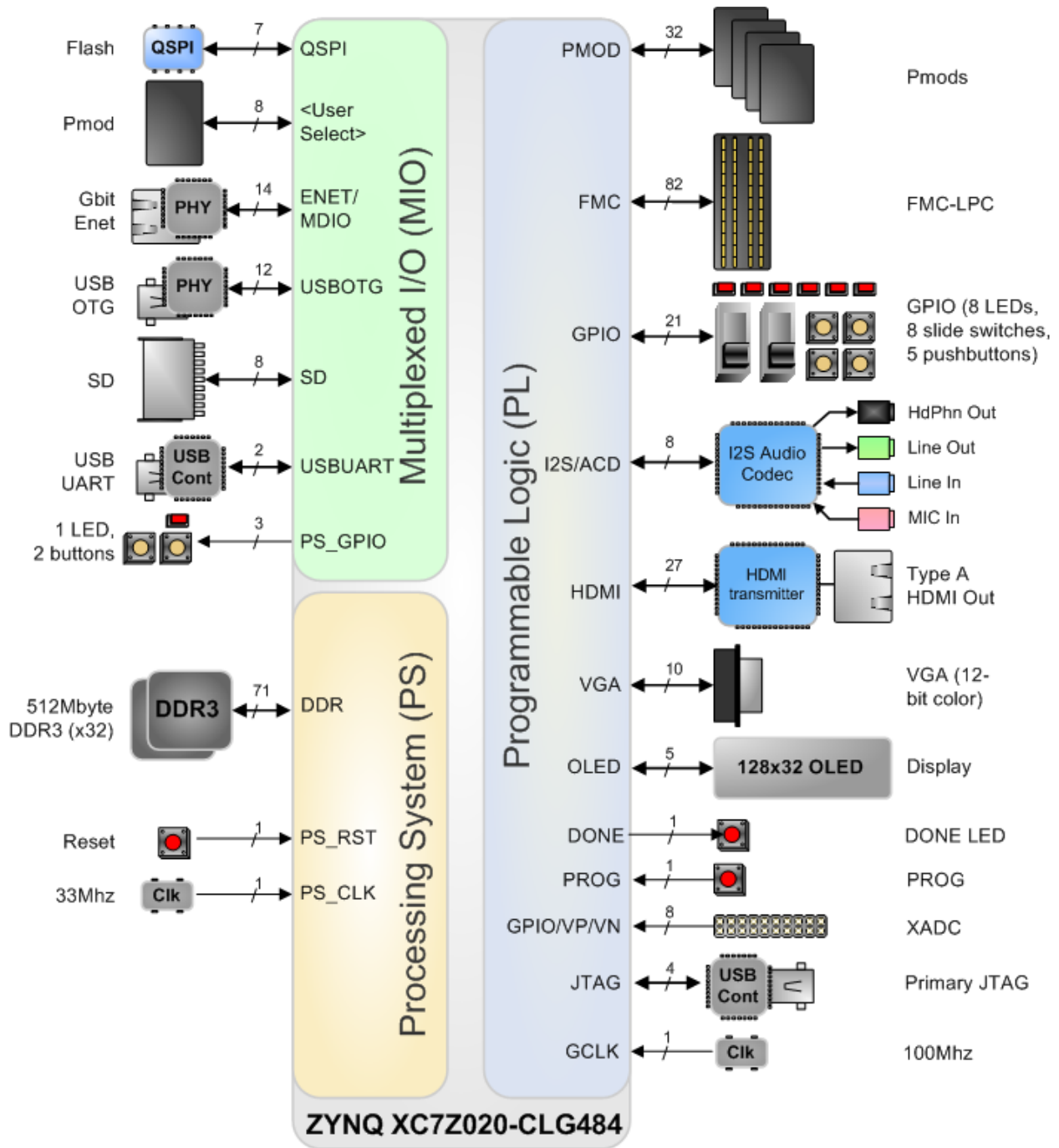

Figure 1 – ZedBoard Hardware Block Diagram

# ZEDBOARD BASIC SETUP AND OPERATION

The ZedBoard SD card is preloaded with an example open source Linux build with a RAMdisk file system. This document was created using a host PC running Windows 7 and the instructions contained would apply directly to a Windows 7 host PC. See Appendix III for an example of how to connect a Linux host PC to ZedBoard. It is also recommended that the host PC also have a wired (RJ-45 connector) Network Interface Card (NIC) that can operate at 100 Mbps or 1000 Mbps.

## Hardware Setup

1. Connect 12 V power supply to barrel jack (J20).
2. Connect the USB-UART port of ZedBoard (J14) which is labeled **UART** to a PC using the MicroUSB cable.
3. Insert the 4GB SD card included with ZedBoard into the SD card slot (J12) located on the underside of ZedBoard PCB. This SD card comes preloaded with demo software and contains a basic Linux configuration used to implement the demos listed in the later sections.
4. Verify the ZedBoard boot mode (JP7-JP11) and MIO0 (JP6) jumpers are set to SD card mode as described in the Hardware Users Guide.

[www.zedboard.org/documentation/1521](http://www.zedboard.org/documentation/1521)

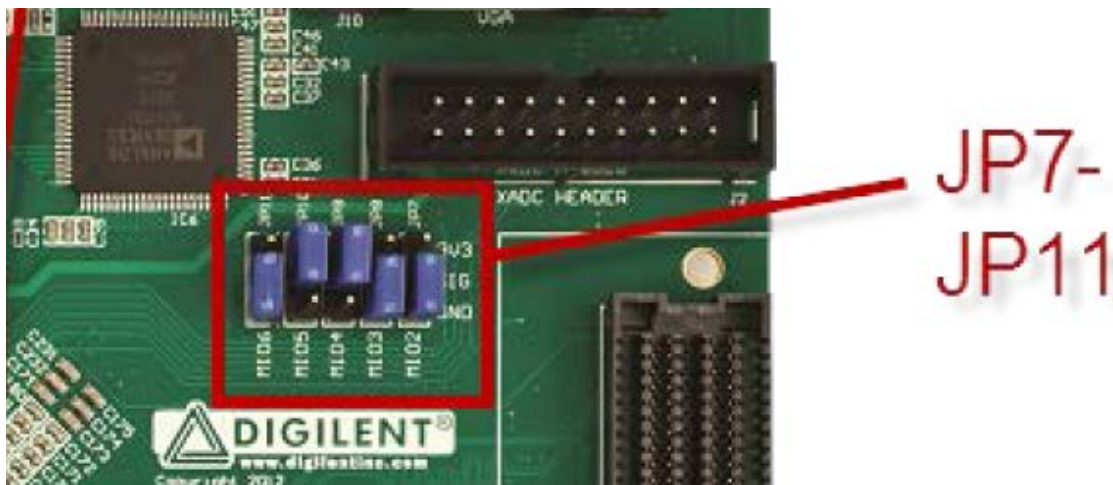

Figure 2 – ZedBoard SD Card Boot Mode Jumper Setting

5. Turn power switch (SW8) to the ON position. ZedBoard will power on and the Green Power Good LED (LD13) should illuminate.
6. The PC may pop-up a dialog box asking for driver installation.

ZedBoard has a USB-UART bridge based on the Cypress CY7C64225 chipset. Use of this feature requires that a USB driver be installed on your Host PC.

If Windows recognizes the USB-UART and loads the software driver, then amber LED D6 will light. Please skip ahead to the next section. However, if the host PC does not recognize the USB-UART and enumerate it as a COM port device refer to the "ZedBoard\_USB-UART\_Setup\_Guide.pdf" document in the link below for instructions on installing this driver. When driver installation is complete, continue to the next step.

7. [www.zedboard.org/documentation/1521](http://www.zedboard.org/documentation/1521)
8. Wait approximately 15 seconds. The blue Done LED (LD12) should illuminate, and a default image will be displayed on the OLED (DISP1).

- Use Device Manager to determine the COM Port.

Note: Each unique USB-UART device attached will enumerate under the next available COM port. Here in this example, the Cypress CY7C64225 USB-UART device is enumerated as COM13.

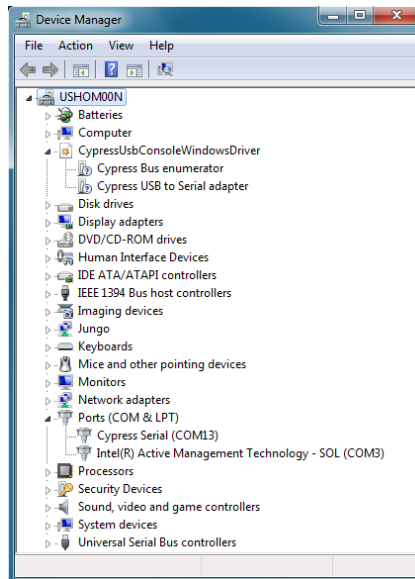

Figure 3 – Device Manager Showing Enumerated USB-UART as COM13

- To enable 'Port Persist' mode double click on the "USB Serial Port (COMx)" or "Cypress Serial (COMx)" port under "Ports (COM & LPT)". Select the "Port Setting" tab. Click the "Advanced" button.

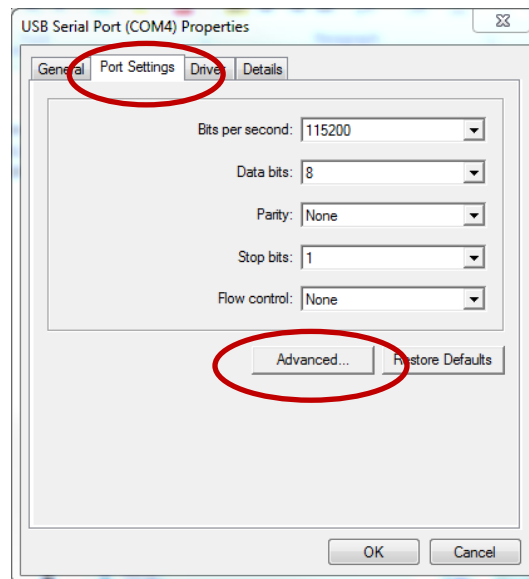

Figure 4 – USB Serial Port Properties Dialog Box

11. Check the “Enable Port Persist” check box in the Advanced Settings dialog box. Click OK to close the Advanced Settings dialog box and again to close the Serial Port Properties box. The Port Persist property should be enabled the next time the serial port is opened.

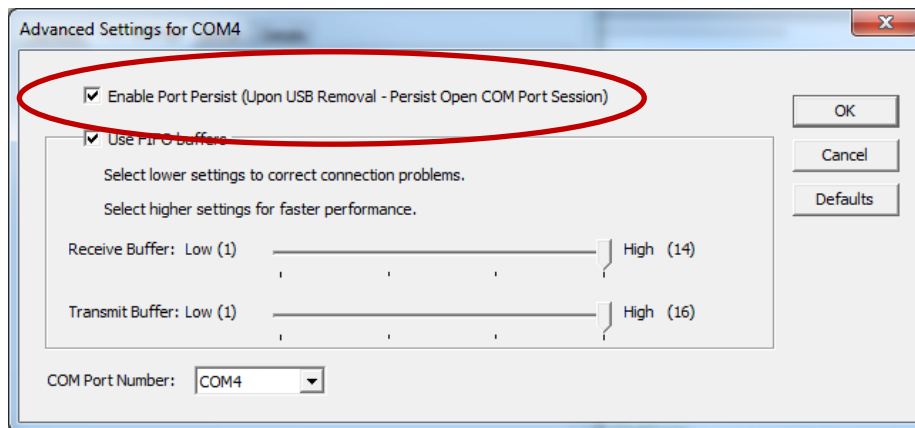

Figure 5 – USB Serial Port Advanced Settings Dialog Box

12. On your PC, open a serial terminal program. For this demo, Windows 7 was used which does not come with a built in terminal application. Tera Term was used in this example which can be downloaded from the Tera Term project on the SourceForge Japan page: [tssh2.sourceforge.jp](http://tssh2.sourceforge.jp)
13. Once Tera Term is installed, Tera Term can be accessed from the desktop or start menu shortcuts.



14. To configure baud rate settings, open the Serial Port Setup window from the **Setup**→**Serial port** menu selection. Select the USB-UART COM port enumeration that matches the listing found in Device Manager. Also set the Baud rate option to 115200, the Data width option to 8-bit, the Parity option to none, the Stop bit option to 1 bit, and the flow control to none. Finally, assign the transmit delay parameters to 10 msec/char and 100 msec/line, and then click OK.

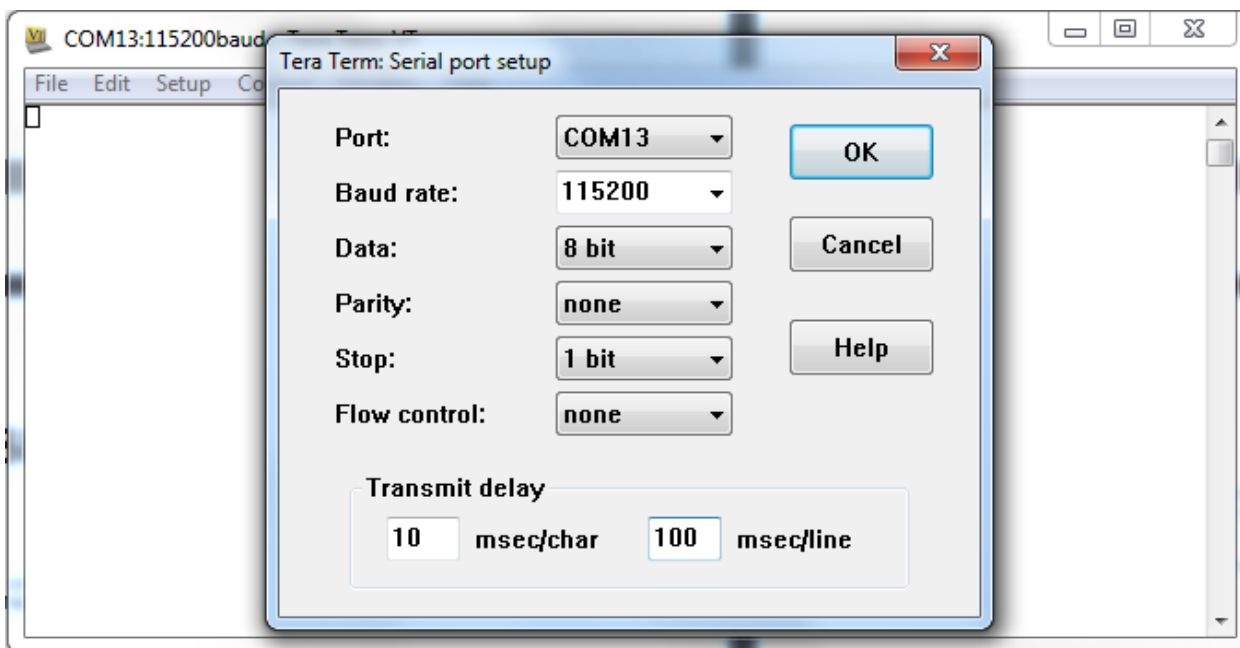
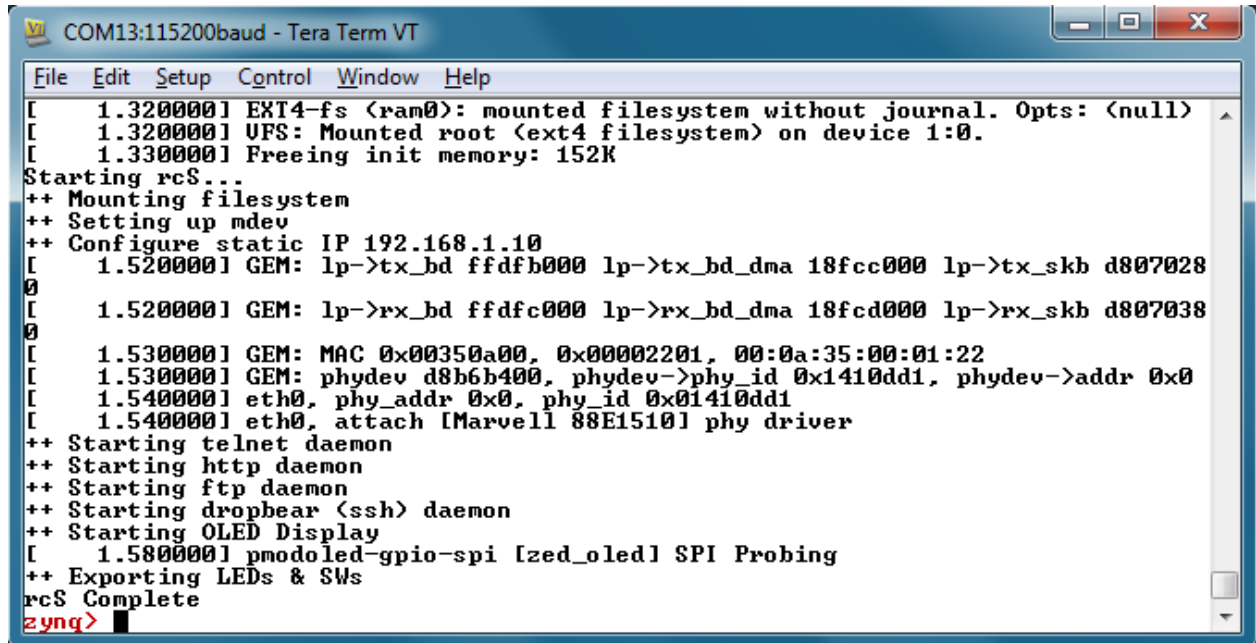

Figure 6 – Tera Term Serial Port Setup Settings

15. Optionally, at this point, the terminal settings can be saved for later use. To do this, use the **Setup→Save setup** menu selection and overwrite the existing TERATERM.INI file.
16. If the amber USB-Link Status (LD11) does not flicker to indicate activity, check the driver installation to determine if the device driver is recognized and enumerated successfully and that there are no errors reported by Windows.

## Linux Startup and Shutdown

1. Cycle power once by turning the power switch (SW8) from ON to OFF and then back ON.
2. In the Terminal Window, a simple Linux image should boot with functionality that demonstrates the basic capabilities of ZedBoard.



```
COM13:115200baud - Tera Term VT
File Edit Setup Control Window Help
[ 1.320000] EXT4-fs (ram0): mounted filesystem without journal. Opts: (null)
[ 1.320000] UFS: Mounted root (ext4 filesystem) on device 1:0.
[ 1.330000] Freeing init memory: 152K
Starting rcS...
++ Mounting filesystem
++ Setting up mdev
++ Configure static IP 192.168.1.10
[ 1.520000] GEM: lp->tx_bd ffdfb000 lp->tx_bd_dma 18fcc000 lp->tx_skb d807028
0
[ 1.520000] GEM: lp->rx_bd ffdfc000 lp->rx_bd_dma 18fcd000 lp->rx_skb d807038
0
[ 1.530000] GEM: MAC 0x00350a00, 0x00002201, 00:0a:35:00:01:22
[ 1.530000] GEM: phydev d8b6b400, phydev->phy_id 0x1410dd1, phydev->addr 0x0
[ 1.540000] eth0, phy_addr 0x0, phy_id 0x01410dd1
[ 1.540000] eth0, attach [Marvell 88E1510] phy driver
++ Starting telnet daemon
++ Starting http daemon
++ Starting ftp daemon
++ Starting dropbear (ssh) daemon
++ Starting OLED Display
[ 1.580000] pmodoled-gpio-spi [zed_oled] SPI Probing
++ Exporting LEDs & SWs
rcS Complete
zynq>
```

Figure 7 – Linux Command Prompt Following Boot

3. When you are done using Linux, run the command `poweroff` and then switch off ZedBoard by positioning the power switch (SW8) from ON to OFF.

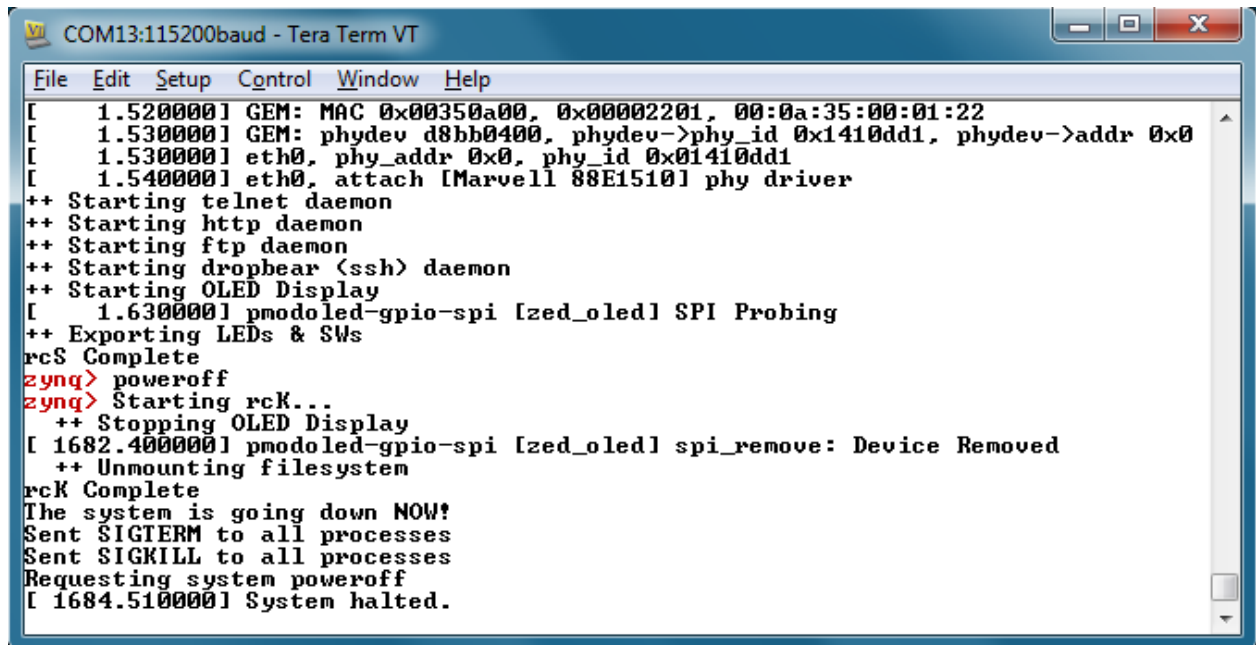

```
COM13:115200baud - Tera Term VT
File Edit Setup Control Window Help
[ 1.520000] GEM: MAC 0x00350a00, 0x00002201, 00:0a:35:00:01:22
[ 1.530000] GEM: phydev d8bb0400, phydev->phy_id 0x1410dd1, phydev->addr 0x0
[ 1.530000] eth0, phy_addr 0x0, phy_id 0x01410dd1
[ 1.540000] eth0, attach [Marvell 88E1510] phy driver
++ Starting telnet daemon
++ Starting http daemon
++ Starting ftp daemon
++ Starting dropbear (ssh) daemon
++ Starting OLED Display
[ 1.630000] pmodoled-gpio-spi [zed_oled] SPI Probing
++ Exporting LEDs & SWs
rcS Complete
zynq> poweroff
zynq> Starting rcK...
++ Stopping OLED Display
[ 1682.400000] pmodoled-gpio-spi [zed_oled] spi_remove: Device Removed
++ Unmounting filesystem
rcK Complete
The system is going down NOW!
Sent SIGTERM to all processes
Sent SIGKILL to all processes
Requesting system poweroff
[ 1684.510000] System halted.
```

Figure 8 – Linux Command Prompt Following Shutdown

## Example Design Description

### ZedBoard System Block Diagram

The following figure illustrates the system design that serves to demonstrate the subsequent interface demos.

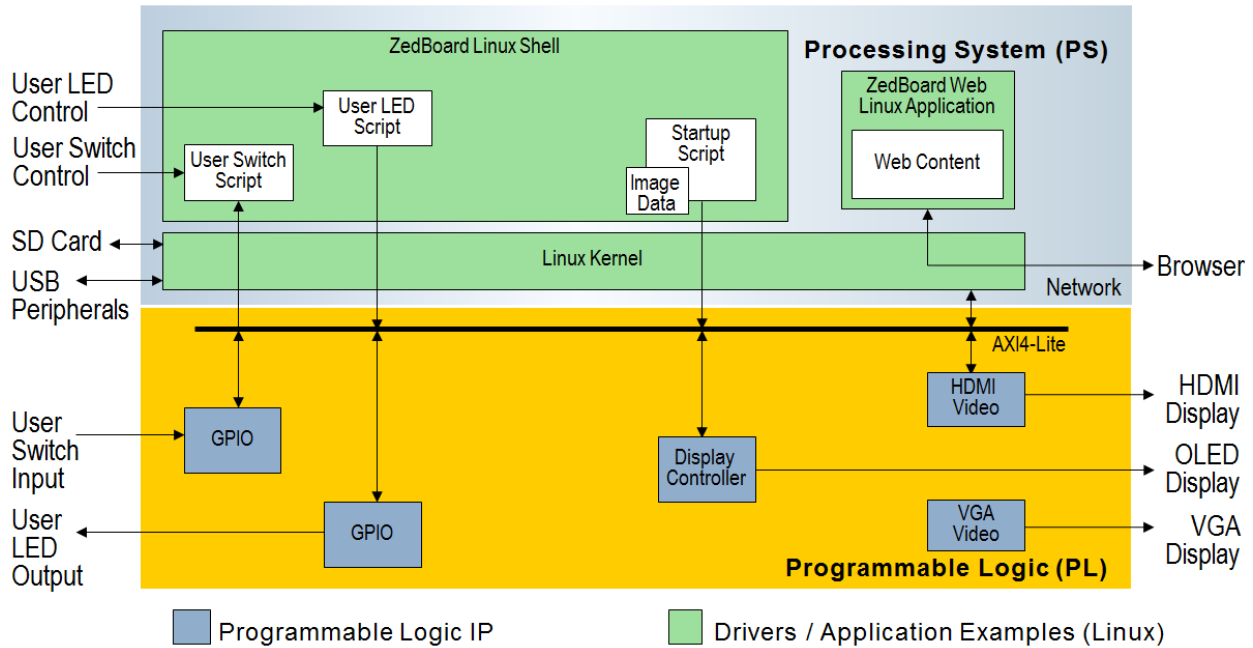

Figure 9 - ZedBoard Example Design Block Diagram

This example design platform is what is included (Programmable Logic provided in Bitstream form) on the ZedBoard SD card and can be used as one of the starting points from which custom designs can be built.

## Demo 1 – Interacting with GPIO Switches and LEDs

### Purpose

This demo shows how software running on the Processing System (PS) of Zynq-7000 AP SoC can interact with the Programmable Logic (PL) hardware to process inputs and outputs through the GPIO implemented in the programmable fabric. This section will also help demonstrate some of the Linux infrastructure that is operational right out of the box.

### Running the Demo on ZedBoard Hardware

1. Setup the basic hardware and boot into Linux as described in the previous section ZedBoard Basic Setup and Operation.
2. A set of scripts are included in the `/usr/bin` directory for interacting with the hardware. To read the state of the user switches (SW0-SW7), first set the position of the switches as desired and then run the `read_sw` script. The state of the switches will be returned as an output in both hexadecimal and decimal formats.

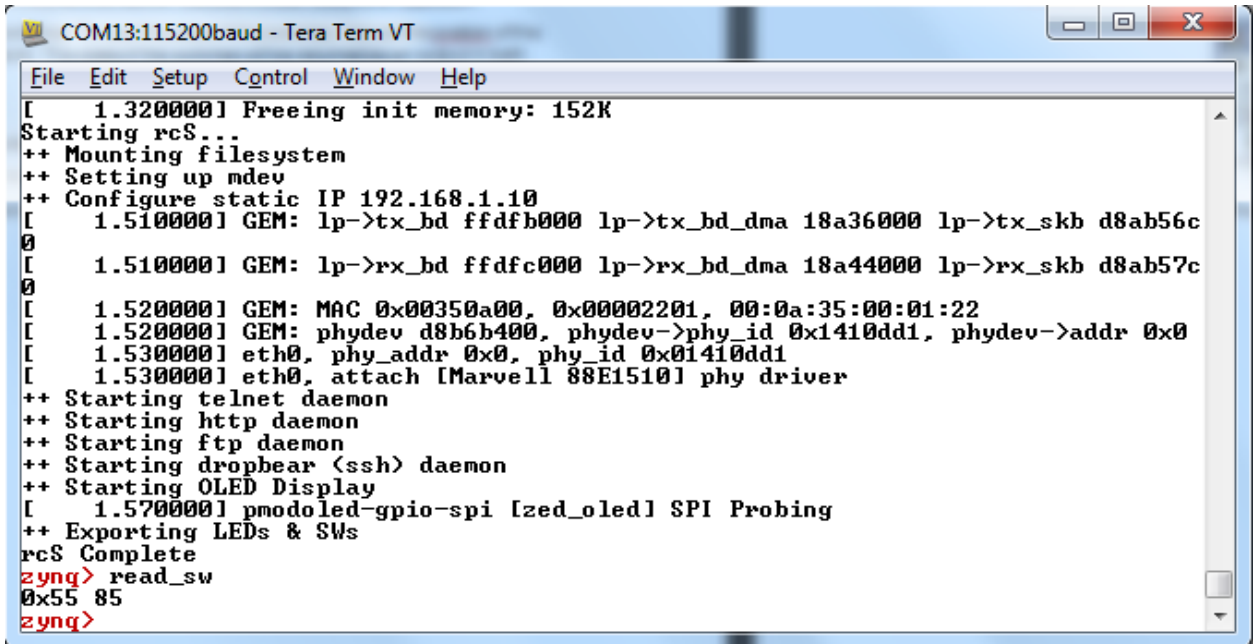

```
COM13:115200baud - Tera Term VT
File Edit Setup Control Window Help
[ 1.320000] Freeing init memory: 152K
Starting rcS...
++ Mounting filesystem
++ Setting up mdev
++ Configure static IP 192.168.1.10
[ 1.510000] GEM: lp->tx_bd ffdfb000 lp->tx_bd_dma 18a36000 lp->tx_skb d8ab56c
0
[ 1.510000] GEM: lp->rx_bd ffdfc000 lp->rx_bd_dma 18a44000 lp->rx_skb d8ab57c
0
[ 1.520000] GEM: MAC 0x00350a00, 0x00002201, 00:0a:35:00:01:22
[ 1.520000] GEM: phydev d8b6b400, phydev->phy_id 0x1410dd1, phydev->addr 0x0
[ 1.530000] eth0, phy_addr 0x0, phy_id 0x01410dd1
[ 1.530000] eth0, attach [Marvell 88E1510] phy driver
++ Starting telnet daemon
++ Starting http daemon
++ Starting ftp daemon
++ Starting dropbear (ssh) daemon
++ Starting OLED Display
[ 1.570000] pmodoled-gpio-spi [zed_oled] SPI Probing
++ Exporting LEDs & SWs
rcS Complete
zynq> read_sw
0x55 85
zynq>
```

Figure 10 - ZedBoard Example Switch Input

3. The `read_sw` script handles the details of reading the GPIO states from the `/sys/class/gpio/gpio$sw/value` sysfs nodes. The position of the switches can be modified and the updated GPIO values read again by running the `read_sw` script.



- A script for changing the state of the LEDs is also included. To set the state of the user LEDs (LD0-LD7), use the script `write_led` and specify the byte value to be written to the LEDs. For example, running the script `write_led 0xFF` or even the command `write_led 255` will result in each of the user LEDs LD0-LD7 illuminating as seen in Figure 8.

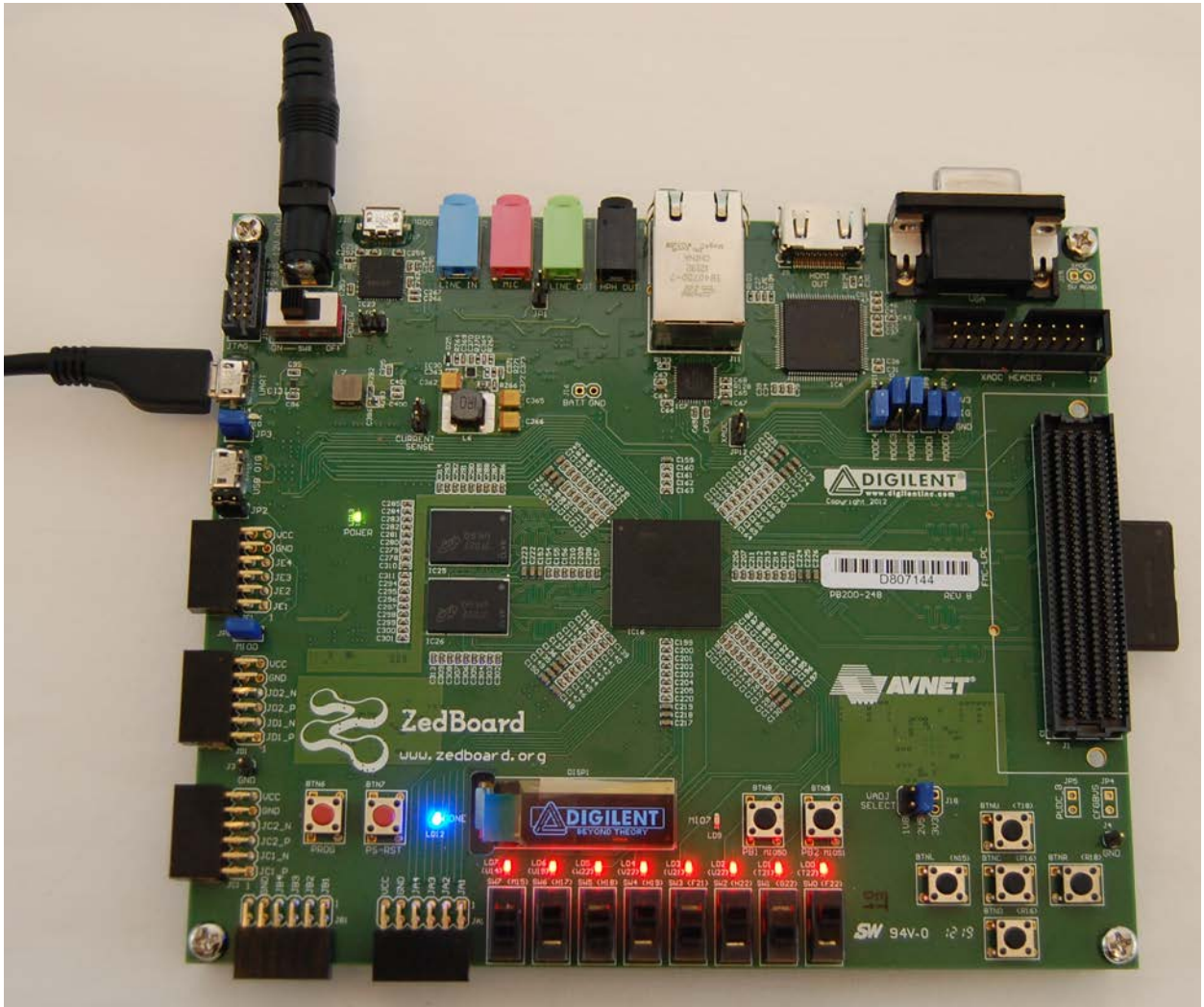

Figure 11 - ZedBoard Example LED Output

- The `write_led` script handles the details of writing the specified values to the `/sys/class/gpio/gpio$led/value` sysfs nodes. The state of the LEDs can be modified again by running the `write_led` script with another output value.
- This concludes Demo 1. Continue to experiment with this demo, proceed to another demo, or run the Linux command `poweroff` and then switch off ZedBoard.

## Demo 2 – OLED Display

### Purpose

This demo shows how software running on the Processing System (PS) of Zynq-7000 AP SoC can interact with the Programmable Logic (PL) hardware via a device driver.

A default Digilent Logo image is displayed on the OLED display (DISP1) after Linux has finished booting. In order to prolong the life of the OLED display, the manufacturer suggests that a specific powerdown sequence be used. Running the `poweroff` command before switching the ZED board off will ensure that this procedure is correctly followed. This section will help demonstrate some of the Linux infrastructure that is used to facilitate the OLED feature.

### Running the Demo on ZedBoard Hardware

1. Setup the basic hardware and boot into Linux as described in the previous section ZedBoard Basic Setup and Operation.
2. A set of scripts are included in the `/usr/bin` directory for interacting with the hardware. To power off the OLED display, run the `unload_oled` script. By running this script, the OLED device driver module `pmdoled-gpio.ko` will be dynamically removed from the kernel during which the OLED is powered off using the recommended sequence and will no longer display the Digilent logo.

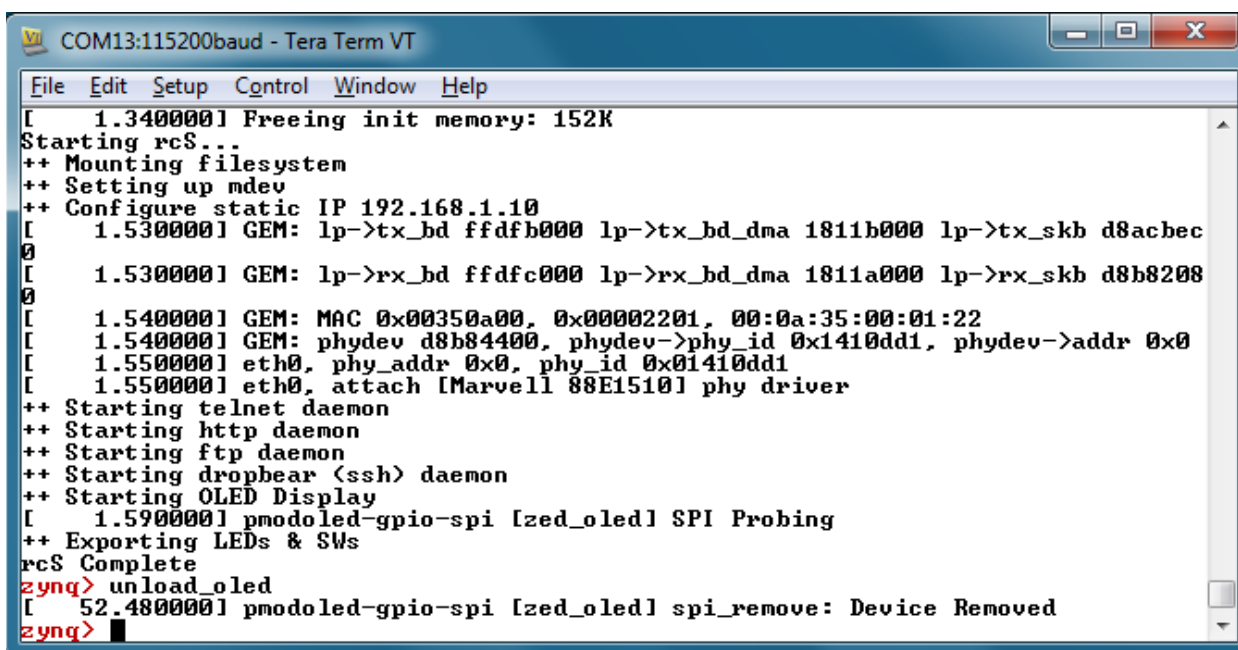

```
COM13:115200baud - Tera Term VT
File Edit Setup Control Window Help
[ 1.340000] Freeing init memory: 152K
Starting rcS...
++ Mounting filesystem
++ Setting up mdev
++ Configure static IP 192.168.1.10
[ 1.530000] GEM: lp->tx_bd ffdfb000 lp->tx_bd_dma 1811b000 lp->tx_skb d8acbec
0
[ 1.530000] GEM: lp->rx_bd ffdfc000 lp->rx_bd_dma 1811a000 lp->rx_skb d8b8208
0
[ 1.540000] GEM: MAC 0x00350a00, 0x00002201, 00:0a:35:00:01:22
[ 1.540000] GEM: phydev d8b84400, phydev->phy_id 0x1410dd1, phydev->addr 0x0
[ 1.550000] eth0, phy_addr 0x0, phy_id 0x01410dd1
[ 1.550000] eth0, attach [Marvell 88E1510] phy driver
++ Starting telnet daemon
++ Starting http daemon
++ Starting ftp daemon
++ Starting dropbear (ssh) daemon
++ Starting OLED Display
[ 1.590000] pmdoled-gpio-spi [zed_oled] SPI Probing
++ Exporting LEDs & SWs
rcS Complete
zynq> unload_oled
[ 52.480000] pmdoled-gpio-spi [zed_oled] spi_remove: Device Removed
zynq>
```

Figure 12 – Turning the OLED Display Off

- To power on the OLED display again, run the `load_oled` script. By running this script, the OLED device driver module `pmdoled-gpio.ko` will be dynamically inserted into the kernel during which it will power on the OLED display using the recommended sequence. Next, the source logo image file `/root/logo.bin` is transferred to the OLED display device node `/dev/zed_oled` and the driver configures the OLED in order to display the Digilent logo.

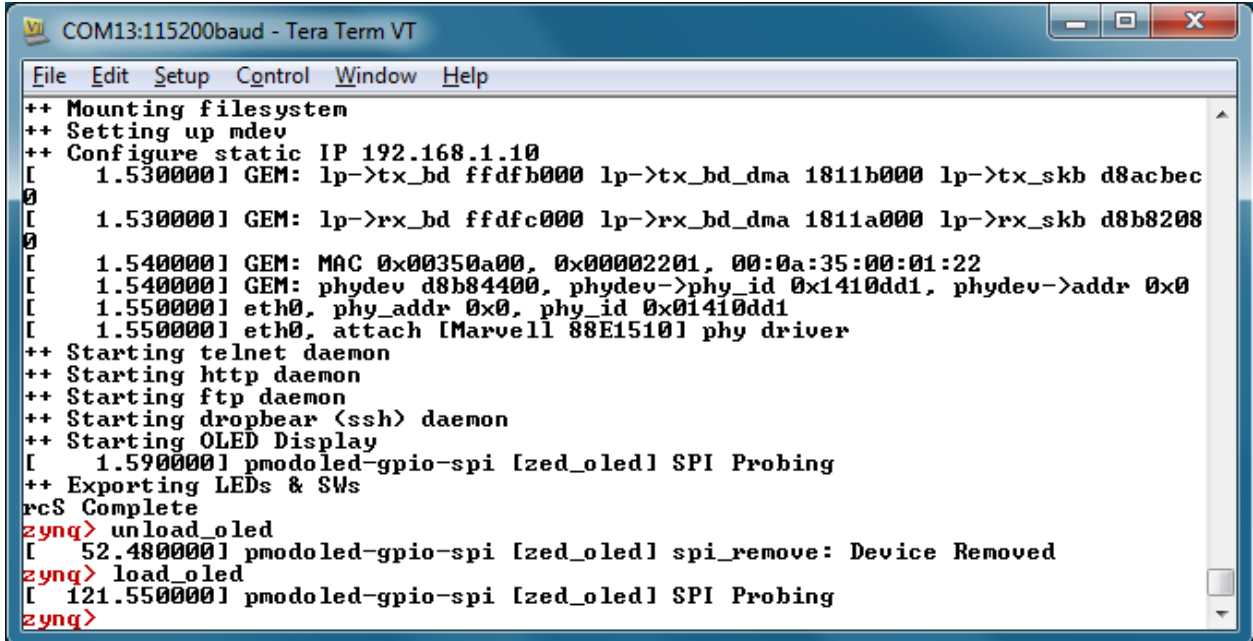

```
COM13:115200baud - Tera Term VT
File Edit Setup Control Window Help
++ Mounting filesystem
++ Setting up mdev
++ Configure static IP 192.168.1.10
[ 1.530000] GEM: lp->tx_bd ffdfb000 lp->tx_bd_dma 1811b000 lp->tx_skb d8acbec
0
[ 1.530000] GEM: lp->rx_bd ffdfc000 lp->rx_bd_dma 1811a000 lp->rx_skb d8b8208
0
[ 1.540000] GEM: MAC 0x00350a00, 0x00002201, 00:0a:35:00:01:22
[ 1.540000] GEM: phydev d8b84400, phydev->phy_id 0x1410dd1, phydev->addr 0x0
[ 1.550000] eth0, phy_addr 0x0, phy_id 0x01410dd1
[ 1.550000] eth0, attach [Marvell 88E1510] phy driver
++ Starting telnet daemon
++ Starting http daemon
++ Starting ftp daemon
++ Starting dropbear (ssh) daemon
++ Starting OLED Display
[ 1.590000] pmdoled-gpio-spi [zed_oled] SPI Probing
++ Exporting LEDs & SWs
rcS Complete
zynq> unload_oled
[ 52.480000] pmdoled-gpio-spi [zed_oled] spi_remove: Device Removed
zynq> load_oled
[ 121.550000] pmdoled-gpio-spi [zed_oled] SPI Probing
zynq>
```

Figure 13 – Turning the OLED Display On

- This concludes Demo 2. Continue to experiment with this demo, proceed to another demo, or run the Linux command `poweroff` and then switch off ZedBoard.

## Demo 3 – VGA Display

### Purpose

This demo shows how Programmable Logic (PL) can drive hardware independently of the software running on the Processing System (PS) of Zynq-7000 AP SoC once the PL Bitstream is loaded. During this demo a test pattern generated by the PL can be observed on a display connected to the video output on the VGA connector.

### Running the Demo on ZedBoard Hardware

1. Setup the basic hardware described in the previous section ZedBoard Basic Setup and Operation.
2. Using a 15-pin D-subminiature VGA cable, attach a VGA display capable of displaying a resolution of at least 640x480 to the ZedBoard video output connector J10 which is labeled **VGA**.
3. Turn power switch (SW8) to the ON position. ZedBoard will power on and the Green Power Good LED (LD13) should illuminate.
4. Wait approximately 15 seconds. The blue Done LED (LD12) should illuminate, and a default image will be displayed on the OLED (DISP1). The VGA test pattern will also show on the display as seen in Figure 11.

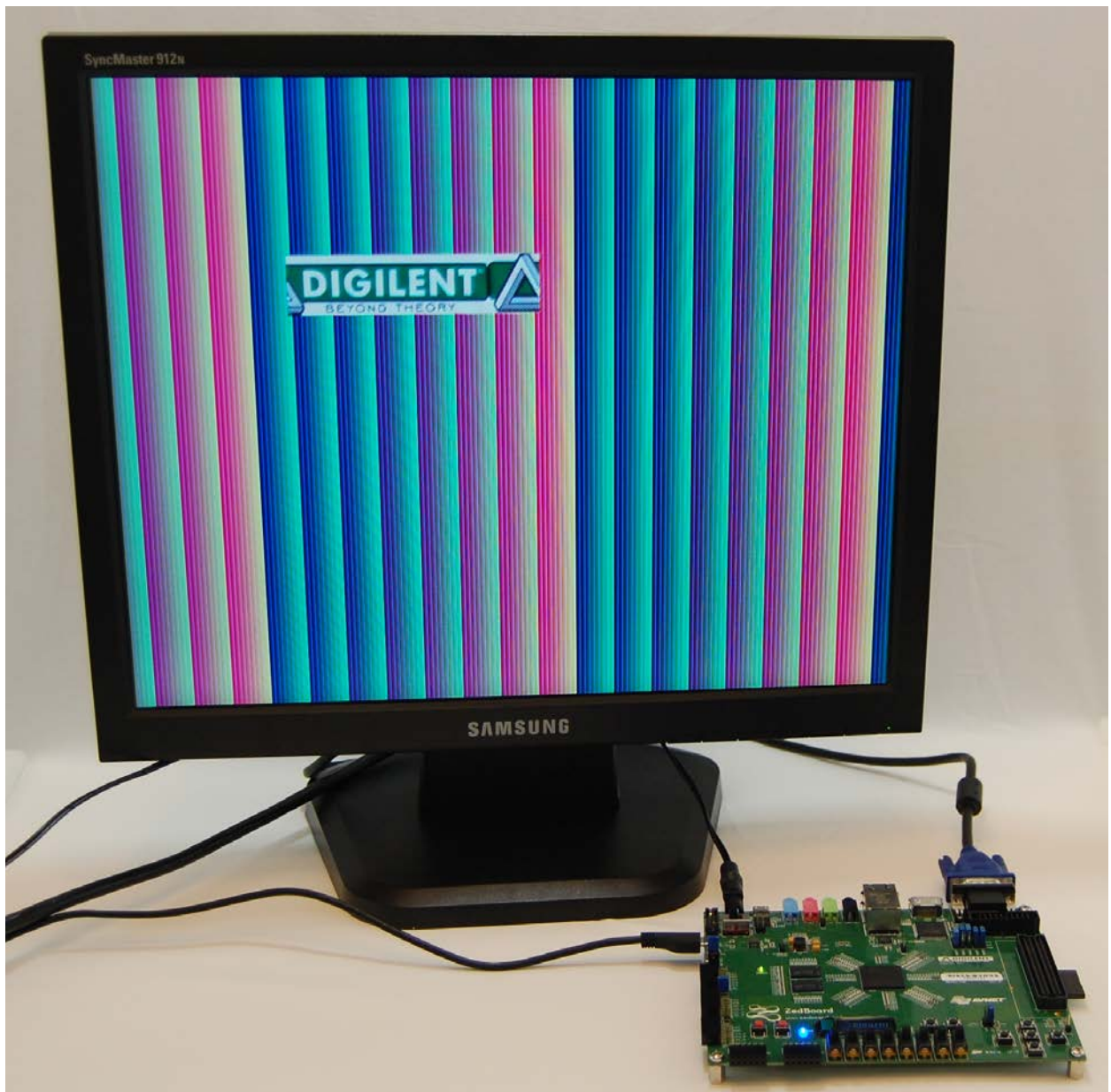

Figure 14 – VGA Output Test Pattern

5. This concludes Demo 3. Continue to experiment with this demo, proceed to another demo, or run the Linux command `poweroff` and then switch off ZedBoard.

## Demo 4 – HDMI Display

### Purpose

This demo shows how software running on the Processing System (PS) of Zynq-7000 AP SoC can interact with the Programmable Logic (PL) hardware via a device driver. During this demo, a default “Tux” Linux logo image is displayed to the HDMI display port after Linux begins booting.

### Running the Demo on ZedBoard Hardware

1. Setup the basic hardware as described in the previous section ZedBoard Basic Setup and Operation.
2. Using an HDMI-to-HDMI cable, attach an HDMI display capable of displaying a resolution of at least 1080p60 to the ZedBoard HD video output connector J9 which is labeled **HDMI OUT**.
3. Turn power switch (SW8) to the ON position. ZedBoard will power on and the Green Power Good LED (LD13) should illuminate.
4. Wait approximately 15 seconds. The blue Done LED (LD12) should illuminate, and a default image will be displayed on the OLED (DISP1). The HDMI output pattern will also show on the display as seen in Figure 12.

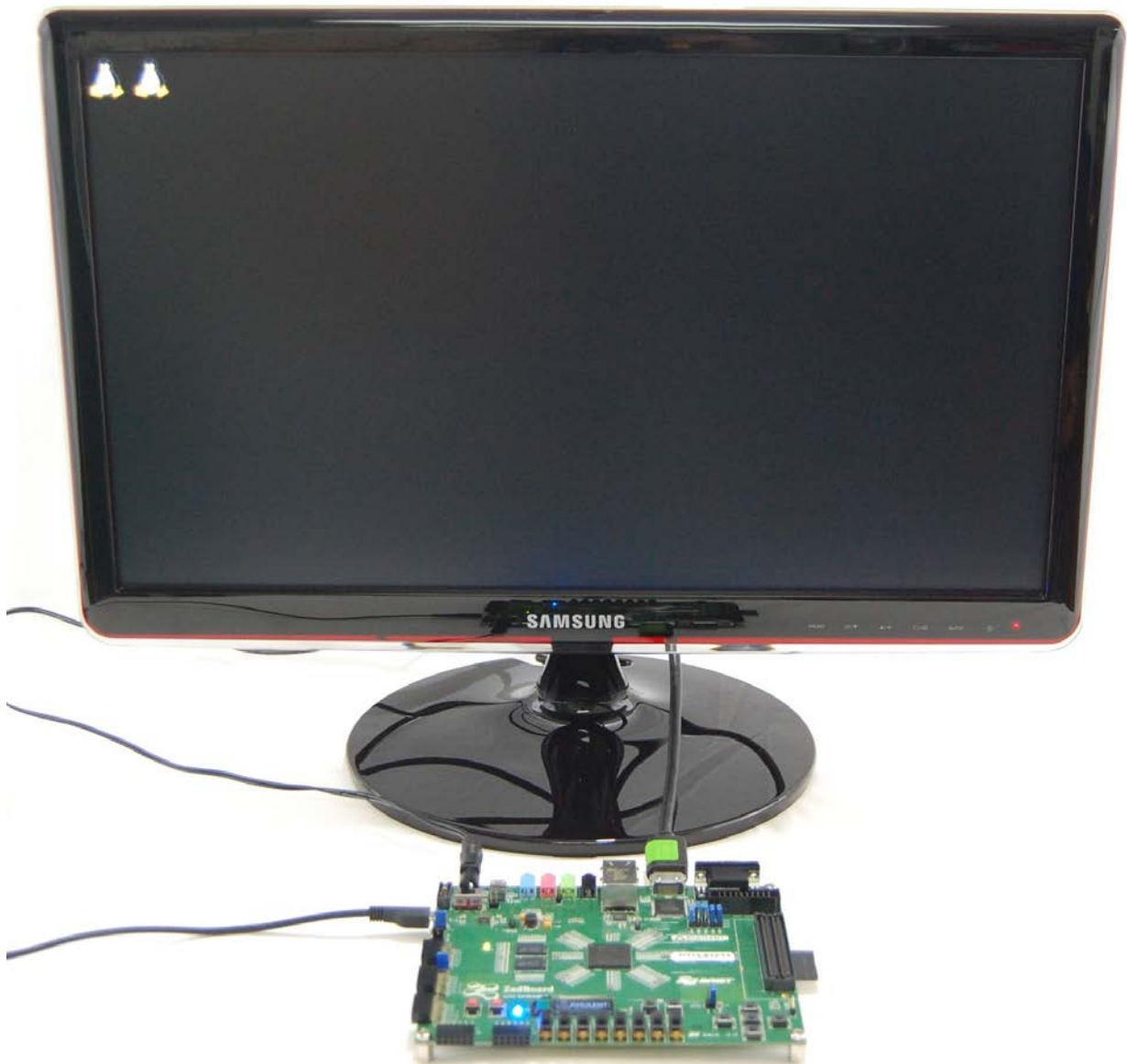

Figure 15 – HDMI Output Pattern

5. This concludes Demo 4. Continue to experiment with this demo, proceed to another demo, or run the Linux command `poweroff` and then switch off ZedBoard.

## Demo 5 – Ethernet

### Purpose

ZedBoard example Linux system found on the included SD card implements a Dropbear SSH server, ftpd FTP server, and Busybox httpd HTTP server at startup. Refer to the documentation on each of these server implementations if you are interested in using them beyond the scope of this document.

### Host PC Networking Configuration

This demo shows the Gigabit Ethernet hardware and networking capability of ZedBoard. To run this demo, you may have to configure the network properties on your PC. The following steps will guide you through this process for a Windows 7 host PC.

1. Attach a standard Ethernet Cable between ZedBoard Gigabit Ethernet Port (J11) and the host PC network interface adapter.
2. Open the **Change adapter settings** from the **Start→Control Panel→Network and Sharing Center**.

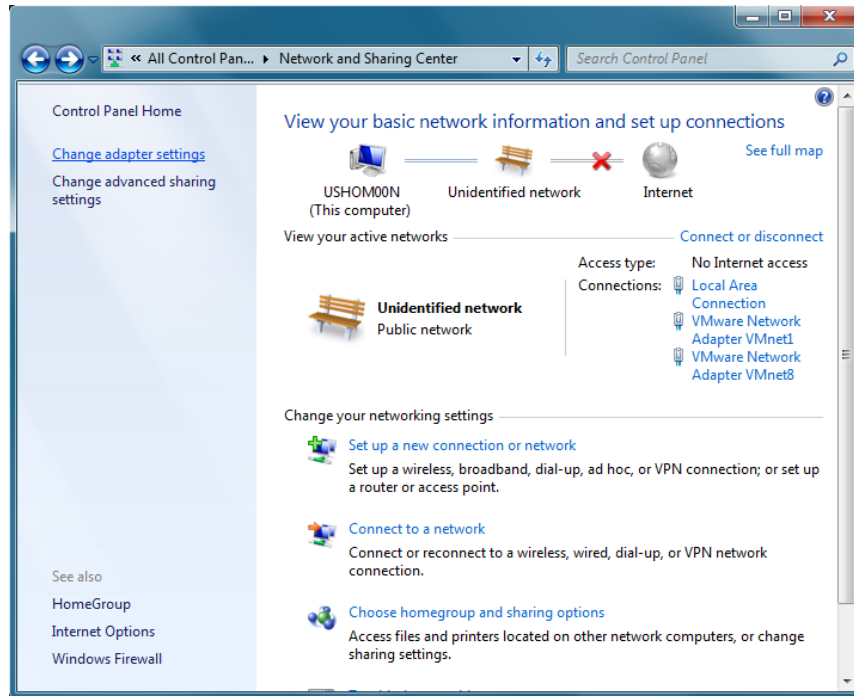

Figure 16 – Network and Sharing Center

3. In the **Network Connections** window, right-click on the Local Area Connection adapter entry corresponding to the network interface that is connected to ZedBoard and select **Properties**.

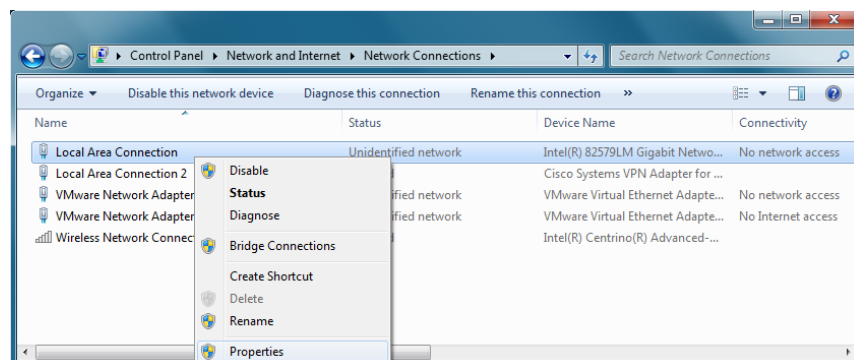

Figure 17 – Network Connections



4. In **Local Area Connection Properties**, select **Internet Protocol Version 4 (TCP/IPv4)**, then click the **Properties** button.

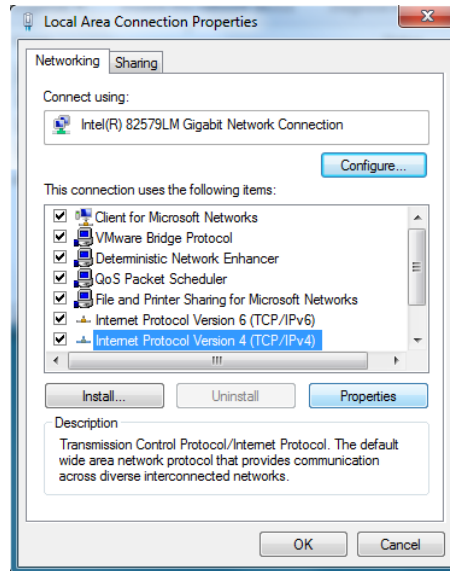

Figure 18 – Local Area Connection Properties

5. Set the IP address to 192.168.1.1 and the Subnet mask to 255.255.255.0 in the **Internet Protocol Version 4 (TCP/IPv4) Properties** window and then click the OK button.

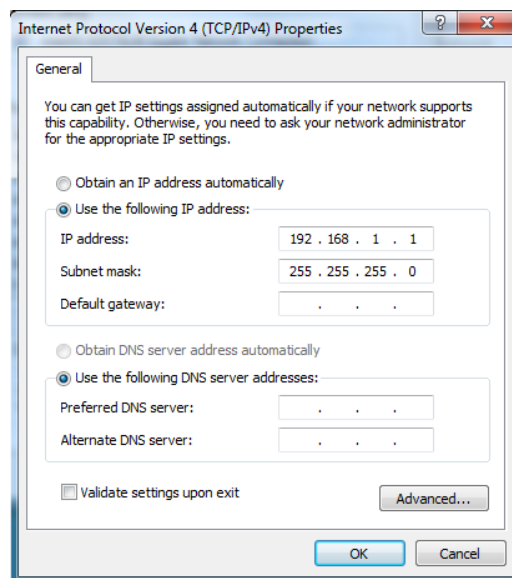

Figure 19 – Internet Protocol Version 4 (TCP/IPv4) Properties

6. The host PC networking is now configured and ready to proceed with the networking hardware demo.

## Running the Demo on ZedBoard Hardware

1. Setup the basic hardware and boot into Linux as described in the previous section ZedBoard Basic Setup and Operation.
2. Verify that a standard Ethernet Cable is connected between ZedBoard Gigabit Ethernet Port (J11) and the host PC network interface adapter.

- The default IP address of ZedBoard Ethernet is set to 192.168.1.10 and this can be verified with the output returned by the `ifconfig` command.

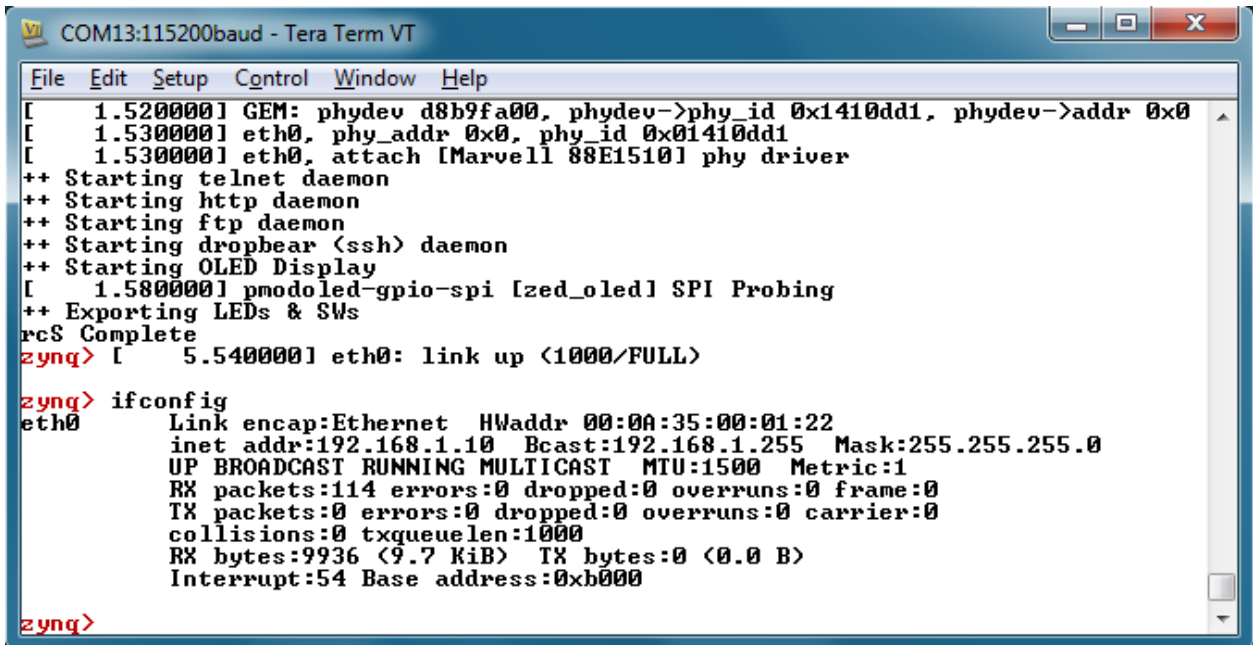

```
COM13:115200baud - Tera Term VT
File Edit Setup Control Window Help
[ 1.520000] GEM: phydev d8b9fa00, phydev->phy_id 0x1410dd1, phydev->addr 0x0
[ 1.530000] eth0, phy_addr 0x0, phy_id 0x01410dd1
[ 1.530000] eth0, attach [Marvell 88E1510] phy driver
++ Starting telnet daemon
++ Starting http daemon
++ Starting ftp daemon
++ Starting dropbear (ssh) daemon
++ Starting OLED Display
[ 1.580000] pmodoled-gpio-spi [zed_oled] SPI Probing
++ Exporting LEDs & SWs
rcS Complete
zynq> [ 5.540000] eth0: link up (1000/FULL)

zynq> ifconfig
eth0      Link encap:Ethernet  HWaddr 00:0A:35:00:01:22
          inet addr:192.168.1.10  Bcast:192.168.1.255  Mask:255.255.255.0
          UP BROADCAST RUNNING MULTICAST  MTU:1500  Metric:1
          RX packets:114 errors:0 dropped:0 overruns:0 frame:0
          TX packets:0 errors:0 dropped:0 overruns:0 carrier:0
          collisions:0 txqueuelen:1000
          RX bytes:9936 (9.7 KiB)  TX bytes:0 (0.0 B)
          Interrupt:54 Base address:0xb000

zynq>
```

Figure 20 – ZedBoard IP Address Revealed with `ifconfig` Command

- To view the ZedBoard embedded webpage, open a web browser (such as Firefox) and browse to the ZedBoard IP address <http://192.168.1.10> as the URL. The ZedBoard webpage should open in the browser to display as seen in Figure 18.

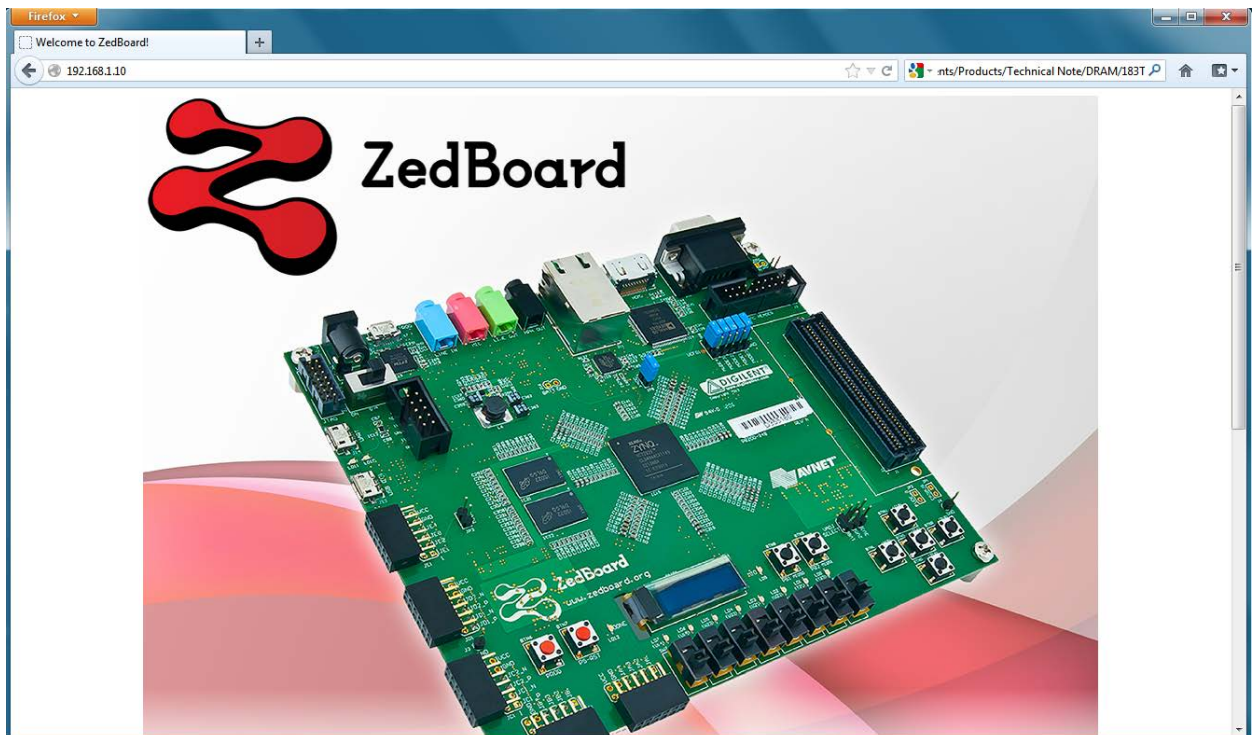

Figure 21 – ZedBoard Webpage Shown In PC Host Browser

- Using an SSH client, such as PuTTY SSH, open a secure terminal connection to the target ZedBoard using the 192.168.1.10 IP address.

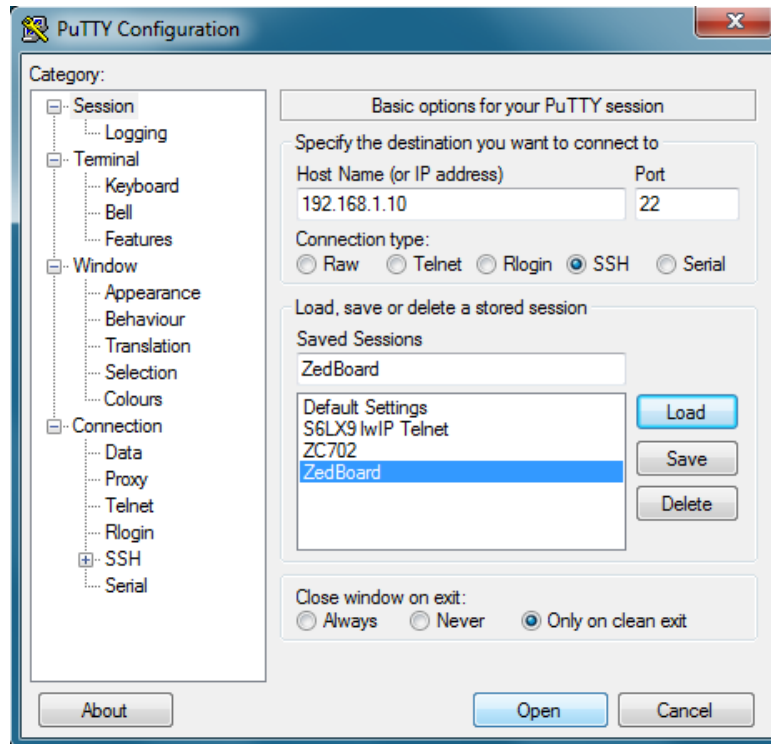

Figure 22 – ZedBoard Webpage Shown In PC Host Browser

- Once the terminal connects, the remote system will prompt for a login. Use the user login **root** and the password **root** to complete the connection.
- The session acts as a remote terminal and commands can be entered as you would on the local serial console.

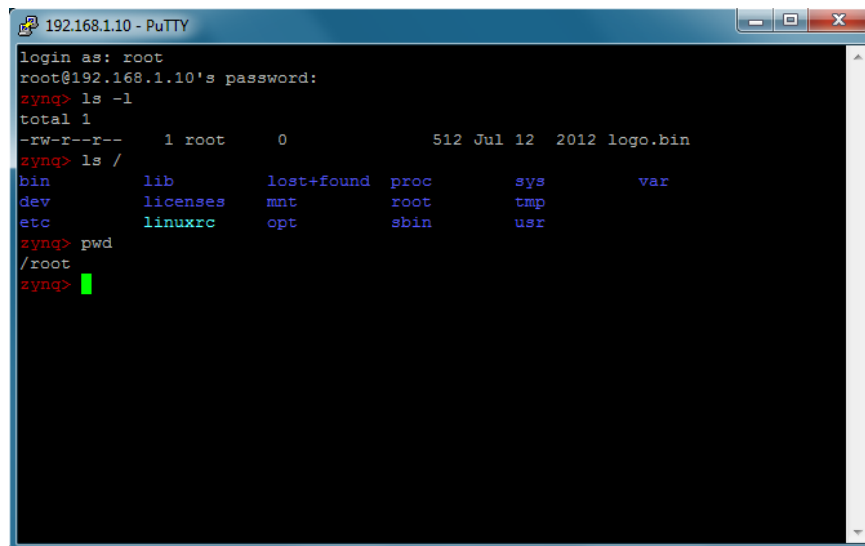
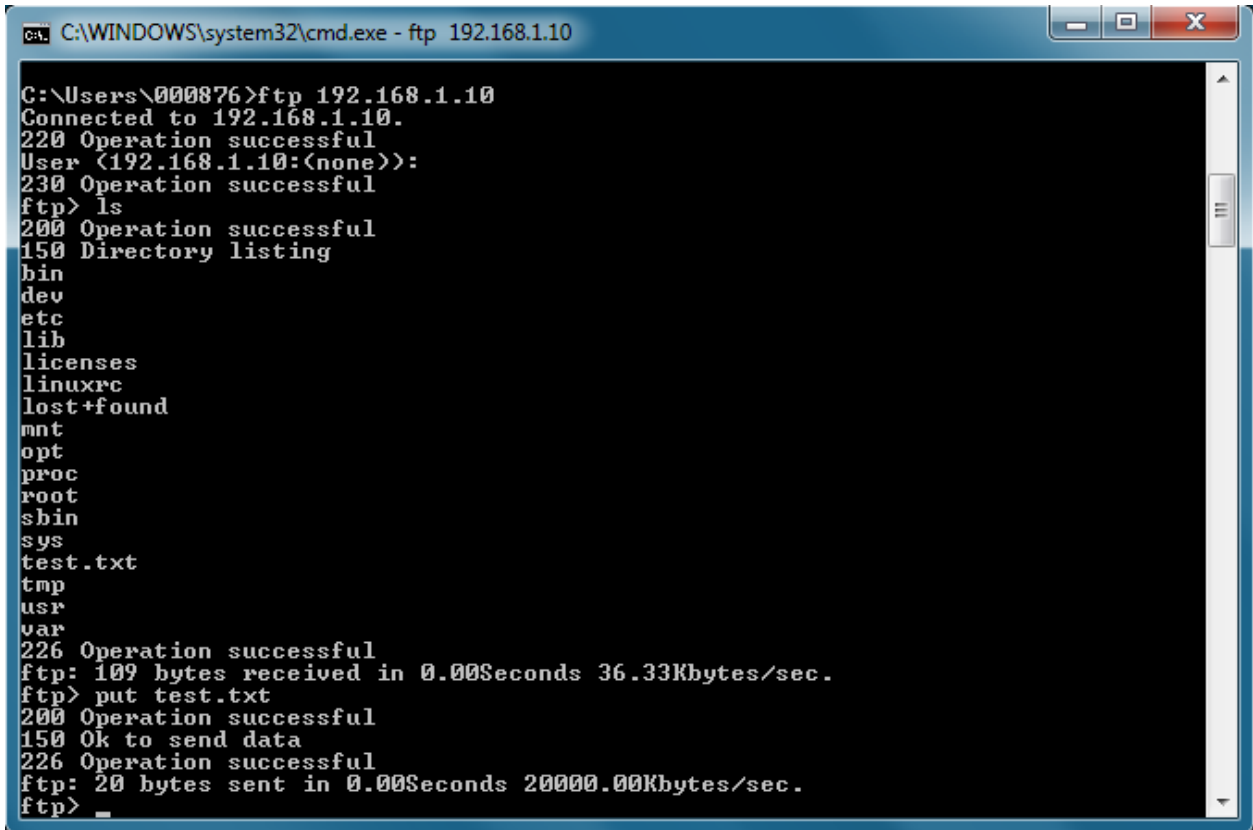

Figure 23 – Remote ZedBoard Terminal via SSH Session

- Logout and close the remote session with the `exit` command.
- Open a Windows Command Prompt.
- Connect an FTP session to the remote host with the command `ftp 192.168.1.10` and use the login **root**.

11. You can use the ftp session to transfer files back and forth across the network to ZedBoard.



```
C:\WINDOWS\system32\cmd.exe - ftp 192.168.1.10

C:\Users\000876>ftp 192.168.1.10
Connected to 192.168.1.10.
220 Operation successful
User (192.168.1.10:(none)):
230 Operation successful
ftp> ls
200 Operation successful
150 Directory listing
bin
dev
etc
lib
licenses
linuxrc
lost+found
mnt
opt
proc
root
sbin
sys
test.txt
tmp
usr
var
226 Operation successful
ftp: 109 bytes received in 0.00Seconds 36.33Kbytes/sec.
ftp> put test.txt
200 Operation successful
150 Ok to send data
226 Operation successful
ftp: 20 bytes sent in 0.00Seconds 20000.00Kbytes/sec.
ftp> _
```

Figure 24 – ZedBoard FTP Session

12. Close the ftp session using the `bye` command.
13. This concludes Demo 5. Continue to experiment with this demo, proceed to another demo, or run the command `poweroff` and then switch off ZedBoard.

## Demo 6 – USB-OTG

### Purpose

This demo shows how a high speed communications peripheral connected to the Processing System (PS) of Zynq-7000 AP SoC can be used to extend the functionality of ZedBoard.

To connect additional USB devices with the ZED board, connect a powered hub to the USB-OTG port. USB devices attached to this hub can then also be accessed in Linux.

### Running the Demo on ZedBoard Hardware

1. Set jumpers JP2 and JP3 to the 1-2 position. This will enable the OTG device for host mode and connect the ZedBoard USB 5V supply to the USB OTG (J13) VBUS line.
2. Setup the basic hardware and boot into Linux as described in the previous section ZedBoard Basic Setup and Operation.
3. Connect a USB thumb drive to the female end of the microUSB-to-Type A adapter cable included with ZedBoard.
4. Connect the microUSB end of the microUSB-to-Type A adapter cable to J13.
5. The USB thumb drive should enumerate and the device indication should display on the serial console. In this example, the primary partition of this USB thumb drive has been enumerated as device `/dev/sda1` as seen in Figure 22.

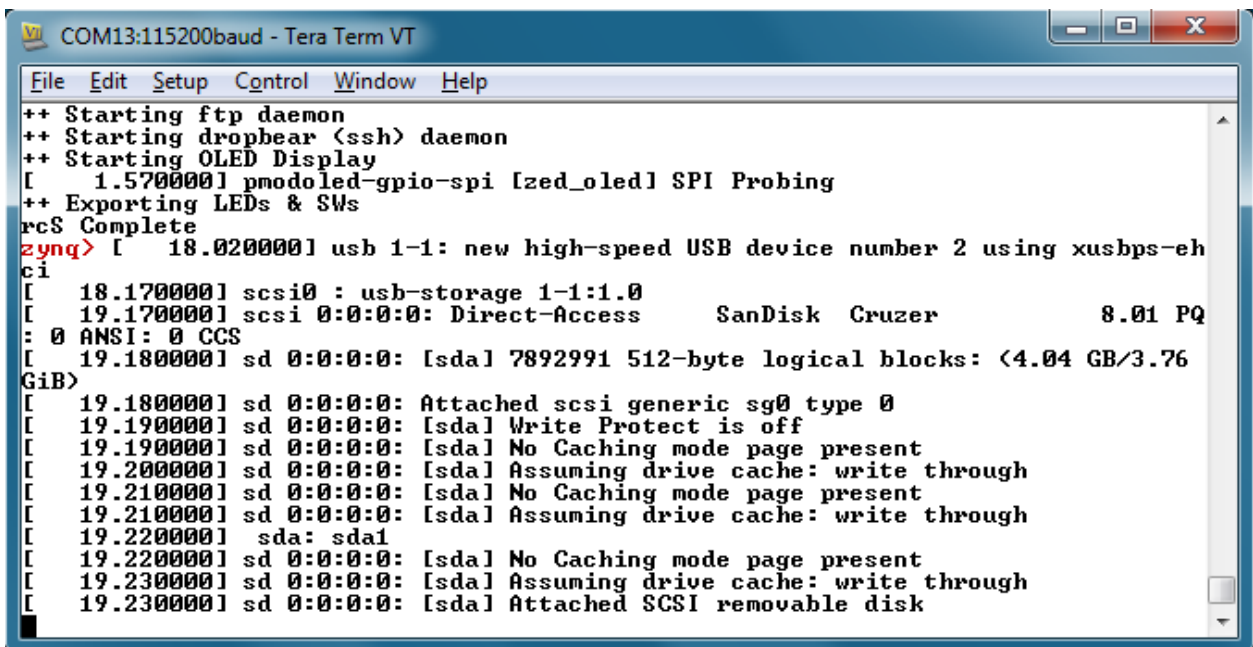
A screenshot of a terminal window titled "COM13:115200baud - Tera Term VT". The terminal displays the following output:

```
++ Starting ftp daemon
++ Starting dropbear (ssh) daemon
++ Starting OLED Display
[ 1.570000] pmodoled-gpio-spi [zed_oled] SPI Probing
++ Exporting LEDs & SWs
rcS Complete
zynq> [ 18.020000] usb 1-1: new high-speed USB device number 2 using xusbps-ehci
[ 18.170000] scsi0 : usb-storage 1-1:1.0
[ 19.170000] scsi 0:0:0:0: Direct-Access      SanDisk  Cruzer           8.01 PQ
: 0 ANSI: 0 CCS
[ 19.180000] sd 0:0:0:0: [sda] 7892991 512-byte logical blocks: <4.04 GB/3.76 GiB>
[ 19.180000] sd 0:0:0:0: Attached scsi generic sg0 type 0
[ 19.190000] sd 0:0:0:0: [sda] Write Protect is off
[ 19.190000] sd 0:0:0:0: [sda] No Caching mode page present
[ 19.200000] sd 0:0:0:0: [sda] Assuming drive cache: write through
[ 19.210000] sd 0:0:0:0: [sda] No Caching mode page present
[ 19.210000] sd 0:0:0:0: [sda] Assuming drive cache: write through
[ 19.220000] sda: sda1
[ 19.220000] sd 0:0:0:0: [sda] No Caching mode page present
[ 19.230000] sd 0:0:0:0: [sda] Assuming drive cache: write through
[ 19.230000] sd 0:0:0:0: [sda] Attached SCSI removable disk
```

Figure 25 – USB Drive Enumeration After Device Insertion

6. Mount the enumerated device to the /mnt mount point using the `mount /dev/sda1 /mnt` command.

```

COM13:115200baud - Tera Term VT
File Edit Setup Control Window Help
++ Starting http daemon
++ Starting ftp daemon
++ Starting dropbear (ssh) daemon
++ Starting OLED Display
[ 1.590000] pmoduled-gpio-spi [zed_oled] SPI Probing
++ Exporting LEDs & SWs
rcS Complete
zynq> [ 2.310000] scsi 0:0:0:0: Direct-Access SanDisk Cruzer 8
_01 PQ: 0 ANSI: 0 CCS
[ 2.320000] sd 0:0:0:0: [sda] 7892991 512-byte logical blocks: (4.04 GB/3.76
GiB)
[ 2.320000] sd 0:0:0:0: Attached scsi generic sg0 type 0
[ 2.330000] sd 0:0:0:0: [sda] Write Protect is off
[ 2.330000] sd 0:0:0:0: [sda] No Caching mode page present
[ 2.340000] sd 0:0:0:0: [sda] Assuming drive cache: write through
[ 2.350000] sd 0:0:0:0: [sda] No Caching mode page present
[ 2.350000] sd 0:0:0:0: [sda] Assuming drive cache: write through
[ 2.360000] sda: sda1
[ 2.360000] sd 0:0:0:0: [sda] No Caching mode page present
[ 2.370000] sd 0:0:0:0: [sda] Assuming drive cache: write through
[ 2.370000] sd 0:0:0:0: [sda] Attached SCSI removable disk
zynq> mount /dev/sda1 /mnt
zynq>

```

Figure 26 – USB Drive Mounted to /mnt

7. The USB drive is now mounted into the root file system at the mount point /mnt which enables read and write file operations to the devices file system. In this example, the thumb drive used has an NTFS file system format.

```

COM13:115200baud - Tera Term VT
File Edit Setup Control Window Help
[ 2.340000] sd 0:0:0:0: Attached scsi generic sg0 type 0
[ 2.350000] sd 0:0:0:0: [sda] Write Protect is off
[ 2.350000] sd 0:0:0:0: [sda] No Caching mode page present
[ 2.360000] sd 0:0:0:0: [sda] Assuming drive cache: write through
[ 2.370000] sd 0:0:0:0: [sda] No Caching mode page present
[ 2.370000] sd 0:0:0:0: [sda] Assuming drive cache: write through
[ 2.380000] sda: sda1
[ 2.380000] sd 0:0:0:0: [sda] No Caching mode page present
[ 2.390000] sd 0:0:0:0: [sda] Assuming drive cache: write through
[ 2.390000] sd 0:0:0:0: [sda] Attached SCSI removable disk
zynq> mount /dev/sda1 /mnt
zynq> cd /mnt/
zynq> ls -l
total 460
drwxr-xr-x 16 root 0 4096 Aug 15 2011 Avnet
drwxr-xr-x 3 root 0 4096 Aug 6 2012 Cypress
drwxr-xr-x 3 root 0 4096 Jan 12 2009 EPI
drwxr-xr-x 11 root 0 4096 Jan 23 2009 Tools
drwxr-xr-x 3 root 0 4096 Jan 12 2009 boot
-rwxr-xr-x 1 root 0 438840 Nov 2 2006 bootmgr
drwxr-xr-x 2 root 0 4096 Jan 12 2009 sources
drwxr-xr-x 3 root 0 4096 Jan 12 2009 winpe_x86
zynq>

```

Figure 27 – Directory Listing of USB Drive

14. The device should be cleanly un-mounted from the system using the command `umount /mnt` before it is removed or the board powered off.

Note: If the device cannot be un-mounted or if a “Device or resource busy” message is shown, make sure that no files or folders of the mounted file system are currently open or that the current working directory is not part of the mounted file system.

15. This concludes Demo 6. Continue to experiment with this demo, proceed to another demo, or run the command `poweroff` and then switch off ZedBoard.

## Demo 7 – SD Card

### Purpose

This demo shows how a storage device connected to the Processing System (PS) of Zynq-7000 AP SoC can be used to extend the functionality of ZedBoard.

The root file system for the example design comes from a RAMdisk image stored on the SD card. This RAMdisk image is copied into a fixed location in DDR3 memory by u-boot prior to Linux boot. Once Linux begins booting, it mounts the RAM file system from the fixed location in DDR3. Any subsequent changes to this file system while ZedBoard is running will not persist through a power cycle or reset.

### Running the Demo on ZedBoard Hardware

1. Setup the basic hardware and boot into Linux as described in the previous section ZedBoard Basic Setup and Operation.
2. The SD card is enumerated as MMC block device `/dev/mmcblk0` and the primary partition on the device is enumerated as device `/dev/mmcblk0p1` as seen in Figure 25.

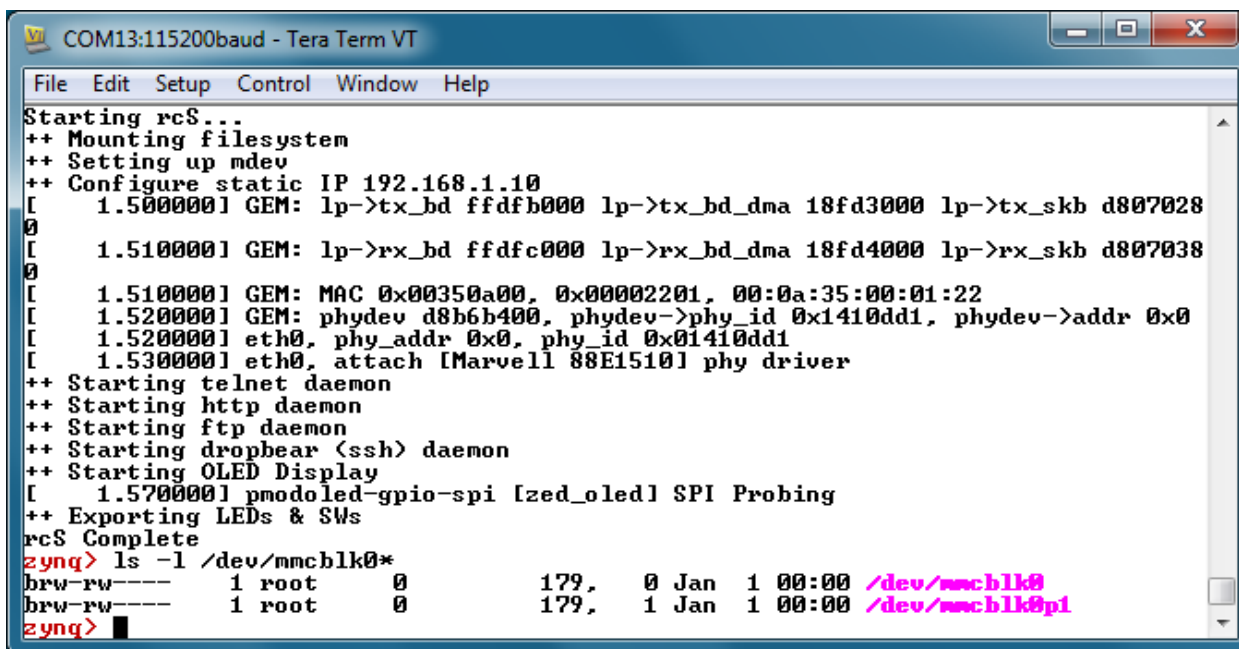

```
COM13:115200baud - Tera Term VT
File Edit Setup Control Window Help
Starting rcS...
++ Mounting filesystem
++ Setting up mdev
++ Configure static IP 192.168.1.10
[ 1.500000] GEM: lp->tx_bd ffdfb000 lp->tx_bd_dma 18fd3000 lp->tx_skb d8070280
[ 1.510000] GEM: lp->rx_bd ffdfc000 lp->rx_bd_dma 18fd4000 lp->rx_skb d8070380
[ 1.510000] GEM: MAC 0x00350a00, 0x00002201, 00:0a:35:00:01:22
[ 1.520000] GEM: phydev d8b6b400, phydev->phy_id 0x1410dd1, phydev->addr 0x0
[ 1.520000] eth0, phy_addr 0x0, phy_id 0x01410dd1
[ 1.530000] eth0, attach [Marvell 88E1510] phy driver
++ Starting telnet daemon
++ Starting http daemon
++ Starting ftp daemon
++ Starting dropbear (ssh) daemon
++ Starting OLED Display
[ 1.570000] pmodoled-gpio-spi [zed_oled] SPI Probing
++ Exporting LEDs & SWs
rcS Complete
zynq> ls -l /dev/mmcblk0*
brw-rw---- 1 root 0 179, 0 Jan 1 00:00 /dev/mmcblk0
brw-rw---- 1 root 0 179, 1 Jan 1 00:00 /dev/mmcblk0p1
zynq>
```

Figure 28 – SD Card Block Device Enumeration

- Mount the enumerated SD card primary partition block device to the /mnt mount point using the mount /dev/mmcb1k0p1 /mnt command.

```

COM13:115200baud - Tera Term VT
File Edit Setup Control Window Help
++ Mounting filesystem
++ Setting up mdev
++ Configure static IP 192.168.1.10
[ 1.500000] GEM: lp->tx_bd ffdfb000 lp->tx_bd_dma 18fd3000 lp->tx_skb d807028
0
[ 1.510000] GEM: lp->rx_bd ffdfc000 lp->rx_bd_dma 18fd4000 lp->rx_skb d807038
0
[ 1.510000] GEM: MAC 0x00350a00, 0x00002201, 00:0a:35:00:01:22
[ 1.520000] GEM: phydev d8b6b400, phydev->phy_id 0x1410dd1, phydev->addr 0x0
[ 1.520000] eth0, phy_addr 0x0, phy_id 0x01410dd1
[ 1.530000] eth0, attach [Marvell 88E1510] phy driver
++ Starting telnet daemon
++ Starting http daemon
++ Starting ftp daemon
++ Starting dropbear (ssh) daemon
++ Starting OLED Display
[ 1.570000] pmodoled-gpio-spi [zed_oled] SPI Probing
++ Exporting LEDs & SWs
rcS Complete
zynq> ls -l /dev/mmcb1k0*
brw-rw---- 1 root 0 179, 0 Jan 1 00:00 /dev/mmcb1k0
brw-rw---- 1 root 0 179, 1 Jan 1 00:00 /dev/mmcb1k0p1
zynq> mount /dev/mmcb1k0p1 /mnt
zynq>

```

Figure 29 – SD Card Mounted to /mnt

- The primary partition of the SD card is now mounted into the root file system at the mount point /mnt which enables read and write operations to files to the SD card file system. In this example, the SD card partition used has a FAT32 file system format.

Note: User LED LD9 is used to indicate read/write activity on the SD card.

```

COM13:115200baud - Tera Term VT
File Edit Setup Control Window Help
[ 1.520000] GEM: phydev d8b6b400, phydev->phy_id 0x1410dd1, phydev->addr 0x0
[ 1.520000] eth0, phy_addr 0x0, phy_id 0x01410dd1
[ 1.530000] eth0, attach [Marvell 88E1510] phy driver
++ Starting telnet daemon
++ Starting http daemon
++ Starting ftp daemon
++ Starting dropbear (ssh) daemon
++ Starting OLED Display
[ 1.570000] pmodoled-gpio-spi [zed_oled] SPI Probing
++ Exporting LEDs & SWs
rcS Complete
zynq> ls -l /dev/mmcb1k0*
brw-rw---- 1 root 0 179, 0 Jan 1 00:00 /dev/mmcb1k0
brw-rw---- 1 root 0 179, 1 Jan 1 00:00 /dev/mmcb1k0p1
zynq> mount /dev/mmcb1k0p1 /mnt
zynq> cd /mnt/
zynq> ls -l
total 10264
-rwxr-xr-x 1 root 0 4317256 Jul 31 2012 BOOT.BIN
-rwxr-xr-x 1 root 0 2779 Jul 31 2012 README
-rwxr-xr-x 1 root 0 5817 Jul 31 2012 devicetree_rawdisk.dtb
-rwxr-xr-x 1 root 0 3694108 Jul 31 2012 rawdisk8M.image.gz
-rwxr-xr-x 1 root 0 2479640 Jul 31 2012 zImage
zynq>

```

Figure 30 – Directory Listing of SD Card

- The SD card device should be cleanly un-mounted from the system using the command umount /mnt before it is removed or the board powered off.

Note: If the device cannot be un-mounted or if a “Device or resource busy” message is shown, make sure that no files or folders of the mounted file system are currently open or that the current working directory is not part of the mounted file system.

- This concludes Demo 7. Continue to experiment with this demo, proceed to another demo, or run the command poweroff and then switch off ZedBoard.



## What's Next

Now that the pre-built ZedBoard example design has been explored, it is time to take a deeper dive into the ZedBoard and see how to modify this design or create a custom design.

To install the Xilinx Vivado Design Edition tools, please see the installation instructions in Appendix I: Installing and Licensing Xilinx Software.

## Where To Get More Information

- Overview and Features of ZedBoard
  - [www.zedboard.org/product/zedboard](http://www.zedboard.org/product/zedboard)
- ZedBoard – Hardware User Guide
  - [www.zedboard.org/documentation/1521](http://www.zedboard.org/documentation/1521)

## Xilinx Website

- Zynq-7000 AP SoC Product Information
  - [www.xilinx.com/zynq](http://www.xilinx.com/zynq)
- ISE WebPACK Design Software
  - [www.xilinx.com/products/design-tools/vivado/index.htm](http://www.xilinx.com/products/design-tools/vivado/index.htm)

## Cypress Website

- CY7C64225 USB-to-UART Driver Download
  - [www.cypress.com/?rID=63794](http://www.cypress.com/?rID=63794)
- CY7C64225 USB-to-UART Device Data Sheet
  - [www.cypress.com/?rID=63304](http://www.cypress.com/?rID=63304)

## Getting Additional Help and Support

### Avnet Support

ZedBoard is a community-oriented kit, with all technical support being offered through the [ZedBoard.org](http://ZedBoard.org) community website support forums. ZedBoard users are encouraged to participate in the forums and offer help to others when possible.

For questions regarding the ZedBoard community website, please direct any questions to:

- ZedBoard.org Web Master – [webmaster@zedboard.org](mailto:webmaster@zedboard.org)

To access the most current collateral for ZedBoard including Reference Designs & Tutorials, Trainings and Videos, Community Projects, and Support Forums please visit the ZedBoard product page at:

- [www.zedboard.org/product/zedboard](http://www.zedboard.org/product/zedboard)

### Xilinx Support

For technical support including the installation and use of the product license file, contact Xilinx Online Technical Support at [www.xilinx.com/support](http://www.xilinx.com/support). The following assistance resources are also available on the website:

- Software, IP and documentation updates
- Access to technical support web tools
- Searchable answer database with over 4,000 solutions
- User forums

## Appendix I: Installing and Licensing Xilinx Software

### Install Vivado Design Edition

The ZedBoard XC7Z020-CLG484-1 Zynq-7000 AP SoC device development is supported by WebPACK licensing. ZedBoard also comes with entitlement voucher to a seat of Vivado Design Edition tools that is device locked to a XC7Z020-CLG484-1 Zynq-7000 AP SoC device. This software can be installed from the included DVD or the latest version can be downloaded online at:

- [www.xilinx.com/support/download/index.htm](http://www.xilinx.com/support/download/index.htm)

If a full seat of ISE Embedded or Vivado Design/System Edition has already been installed, then no further software will be needed. Please check online for any updates at:

- [www.xilinx.com/support/download/index.htm](http://www.xilinx.com/support/download/index.htm)

For detailed instructions on installing and licensing the Xilinx tools, please refer to the **Xilinx Licensing Solution Center** on the Xilinx website:

[www.xilinx.com/support/licensing\\_solution\\_center.htm](http://www.xilinx.com/support/licensing_solution_center.htm)

Note: If the 14.x ISE tools are being installed, a full install of ISE Logic, Embedded, or System Edition is recommended even when using WebPACK licensing. See this Xilinx Answer Record for further details:

- [www.xilinx.com/support/answers/47839.htm](http://www.xilinx.com/support/answers/47839.htm)

## Appendix II: QSPI Flash Example Application

### Boot ZedBoard from QSPI

The ZedBoard comes from the factory with a very simple example application loaded into the Spansion QSPI Flash (IC14/IC15). If the contents of the QSPI flash are unaltered, it should be possible to boot the Zynq-7000 AP SoC device into the very simple application loaded from the QSPI Flash memory as described below.

Verify the ZedBoard boot mode jumpers (JP7-JP11) are set to QSPI flash mode as described in the Hardware Users Guide.

[www.zedboard.org/documentation/1521](http://www.zedboard.org/documentation/1521)

The example application will boot the Processing System using QSPI flash as the boot source and configure the Programmable Logic using a simple Bitstream file which displays a test pattern on User LEDs LD0-LD7 as seen in figure 28.

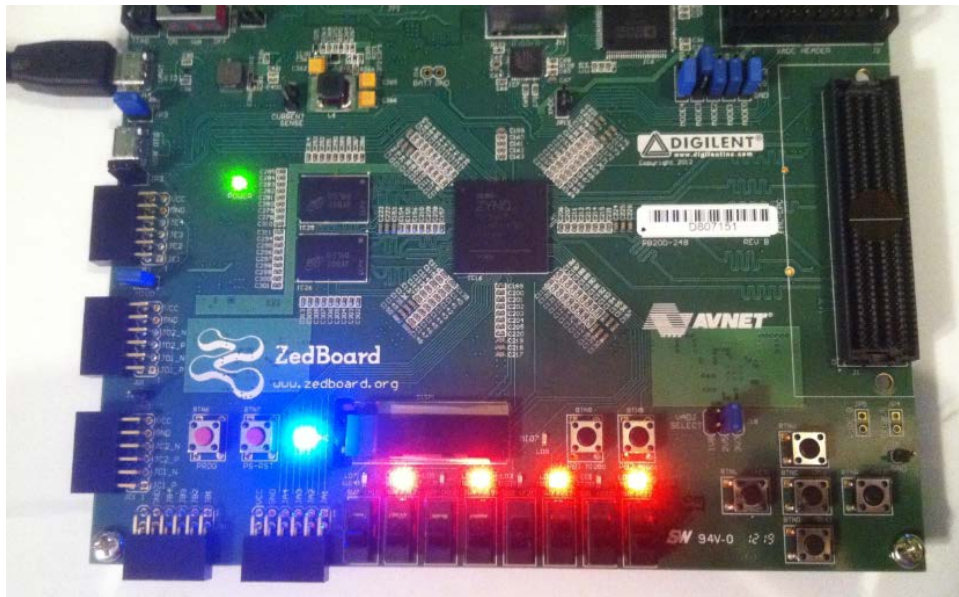

Figure 28 – QSPI Application Example Output

## Appendix III: Using Linux Host PC

The instructions in this section were completed using an Ubuntu 10.04 LTS install running on an Intel MacBook Pro but results may vary for different host machine hardware and Linux distributions.

### Connect Terminal to ZedBoard USB-UART

The ZedBoard Cypress CY7C64225 USB-UART device is capable of enumerating as a USB tty device on most Linux hosts.

After powering on and connecting ZedBoard to the host Linux machine, search the kernel messaging with the command `dmesg | grep tty` and look for indication that the USB-UART is enumerated as a device. In this example, the Linux host has enumerated the ZedBoard USB-UART as the `/dev/ttyACM0` device.

Using the attached USB-UART tty device, connect to the device with the minicom application. In this example, minicom is launched with the `minicom -D /dev/ttyACM0 -b 115200 -8 -o` command as seen in Figure 29.

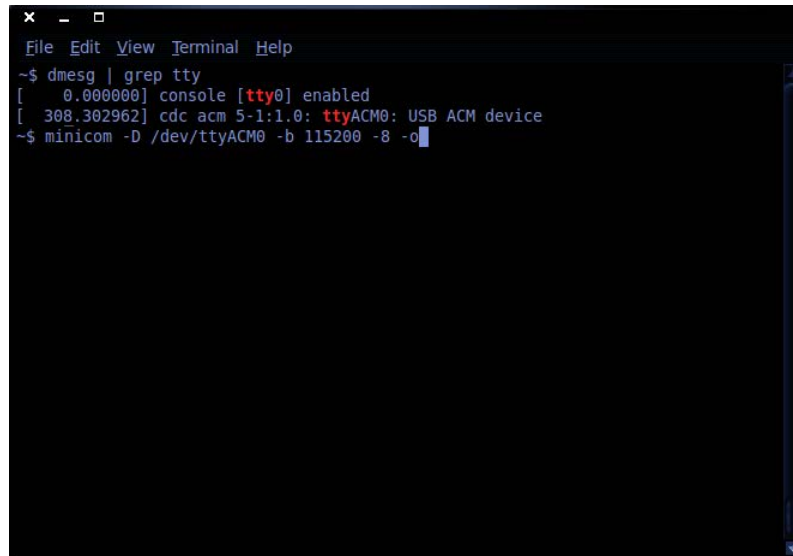
A terminal window with a dark background and light text. The window title bar shows 'x \_ □' and menu options 'File Edit View Terminal Help'. The terminal content shows the following commands and output:

```
-$ dmesg | grep tty
[  0.000000] console [tty0] enabled
[ 308.302962] cdc_acm 5-1:1.0: ttyACM0: USB ACM device
-$ minicom -D /dev/ttyACM0 -b 115200 -8 -o
```

Figure 29 – Determining the Host tty Device and Launching minicom

The minicom terminal will connect and allow the ZedBoard terminal output to be interacted with as seen in Figure 30.

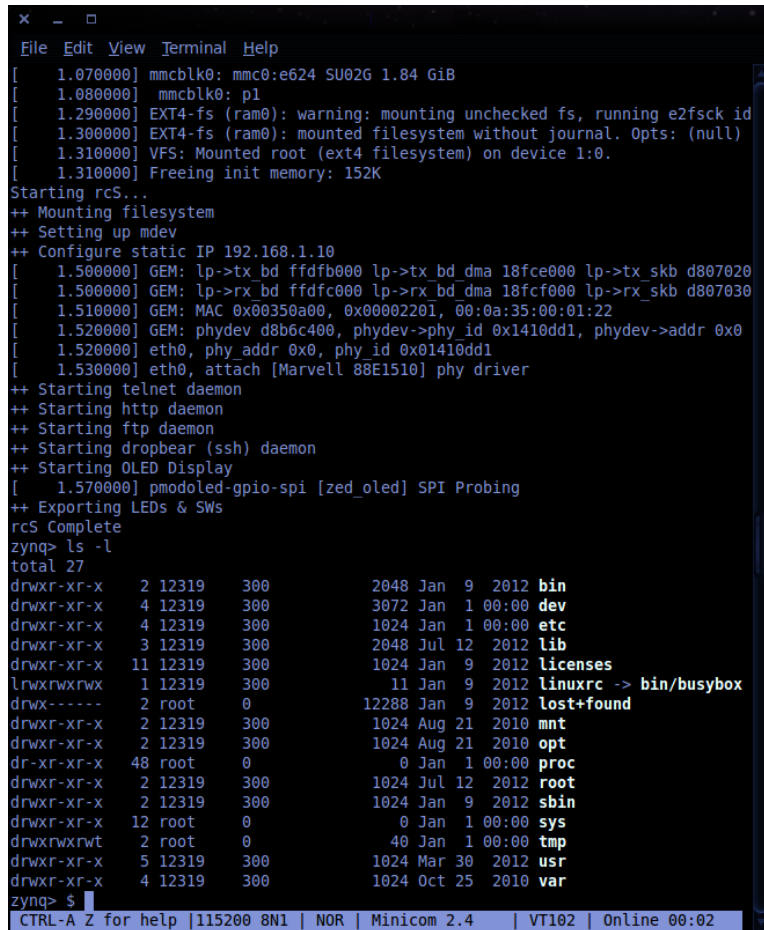

```
File Edit View Terminal Help
[ 1.070000] mmcblk0: mmc0:e624 SU02G 1.84 GiB
[ 1.080000] mmcblk0: p1
[ 1.290000] EXT4-fs (ram0): warning: mounting unchecked fs, running e2fsck id
[ 1.300000] EXT4-fs (ram0): mounted filesystem without journal. Opts: (null)
[ 1.310000] VFS: Mounted root (ext4 filesystem) on device 1:0.
[ 1.310000] Freeing init memory: 152K
Starting rcS...
++ Mounting filesystem
++ Setting up mdev
++ Configure static IP 192.168.1.10
[ 1.500000] GEM: lp->tx_bd ffdfb000 lp->tx_bd_dma 18fce000 lp->tx_skb d807020
[ 1.500000] GEM: lp->rx_bd ffdfc000 lp->rx_bd_dma 18fcf000 lp->rx_skb d807030
[ 1.510000] GEM: MAC 0x00350a00, 0x00002201, 00:0a:35:00:01:22
[ 1.520000] GEM: phydev d8b6c400, phydev->phy_id 0x1410dd1, phydev->addr 0x0
[ 1.520000] eth0, phy_addr 0x0, phy_id 0x01410dd1
[ 1.530000] eth0, attach [Marvell 88E1510] phy driver
++ Starting telnet daemon
++ Starting http daemon
++ Starting ftp daemon
++ Starting dropbear (ssh) daemon
++ Starting OLED Display
[ 1.570000] pmodoled-gpio-spi [zed_oled] SPI Probing
++ Exporting LEDs & SWs
rcS Complete
zynq> ls -l
total 27
drwxr-xr-x 2 12319 300 2048 Jan 9 2012 bin
drwxr-xr-x 4 12319 300 3072 Jan 1 00:00 dev
drwxr-xr-x 4 12319 300 1024 Jan 1 00:00 etc
drwxr-xr-x 3 12319 300 2048 Jul 12 2012 lib
drwxr-xr-x 11 12319 300 1024 Jan 9 2012 licenses
lrwxrwxrwx 1 12319 300 11 Jan 9 2012 linuxrc -> bin/busybox
drwx----- 2 root 0 12288 Jan 9 2012 lost+found
drwxr-xr-x 2 12319 300 1024 Aug 21 2010 mnt
drwxr-xr-x 2 12319 300 1024 Aug 21 2010 opt
dr-xr-xr-x 48 root 0 0 Jan 1 00:00 proc
drwxr-xr-x 2 12319 300 1024 Jul 12 2012 root
drwxr-xr-x 2 12319 300 1024 Jan 9 2012/sbin
drwxr-xr-x 12 root 0 0 Jan 1 00:00 sys
drwxrwxrwt 2 root 0 40 Jan 1 00:00 tmp
drwxr-xr-x 5 12319 300 1024 Mar 30 2012 usr
drwxr-xr-x 4 12319 300 1024 Oct 25 2010 var
zynq> $
CTRL-A Z for help |115200 8N1 | NOR | Minicom 2.4 | VT102 | Online 00:02
```

Figure 30 – Using minicom to Interact with ZedBoard Console

## Connect Networking to ZedBoard USB-UART

The ZedBoard Ethernet networking is capable of interacting with most Linux hosts. To run this demo, you may have to configure the network properties on your Linux machine and assign a static IP address of 192.168.1.1 to connect to ZedBoard.

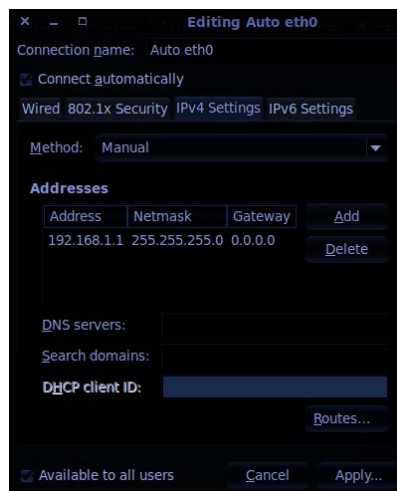

Figure 31 – Assigning Static IP Address to Linux Host Machine

The networking interface may need to be restarted for the IP address assignment changes to take effect. This can be done by running the `ifconfig eth0 down` and `ifconfig eth0 up` command sequences as seen in Figure 32.

```
File Edit View Terminal Help
~$ sudo ifconfig eth0 down
~$ sudo ifconfig eth0 down
~$ sudo ifconfig eth0 up
~$ ifconfig
eth0      Link encap:Ethernet  HWaddr 00:1b:63:a0:2e:6e
          inet addr:192.168.1.1  Bcast:192.168.1.255  Mask:255.255.255.0
          inet6 addr: fe80::21b:63ff:fea0:2e6e/64 Scope:Link
          UP BROADCAST RUNNING MULTICAST  MTU:1500  Metric:1
          RX packets:428 errors:0 dropped:0 overruns:0 frame:0
          TX packets:289 errors:0 dropped:0 overruns:0 carrier:0
          collisions:0 txqueuelen:1000
          RX bytes:601764 (601.7 KB)  TX bytes:30024 (30.0 KB)
          Interrupt:17

lo        Link encap:Local Loopback
          inet addr:127.0.0.1  Mask:255.0.0.0
          inet6 addr: ::1/128 Scope:Host
          UP LOOPBACK RUNNING  MTU:16436  Metric:1
          RX packets:242 errors:0 dropped:0 overruns:0 frame:0
          TX packets:242 errors:0 dropped:0 overruns:0 carrier:0
          collisions:0 txqueuelen:0
          RX bytes:18684 (18.6 KB)  TX bytes:18684 (18.6 KB)

~$
```

Figure 32 – Restarting the Networking Interface

To view the ZedBoard embedded webpage, open a web browser (such as Firefox) and browse to the ZedBoard IP address <http://192.168.1.10/> as the URL. The ZedBoard webpage should open in the browser to display as seen in Figure 33.

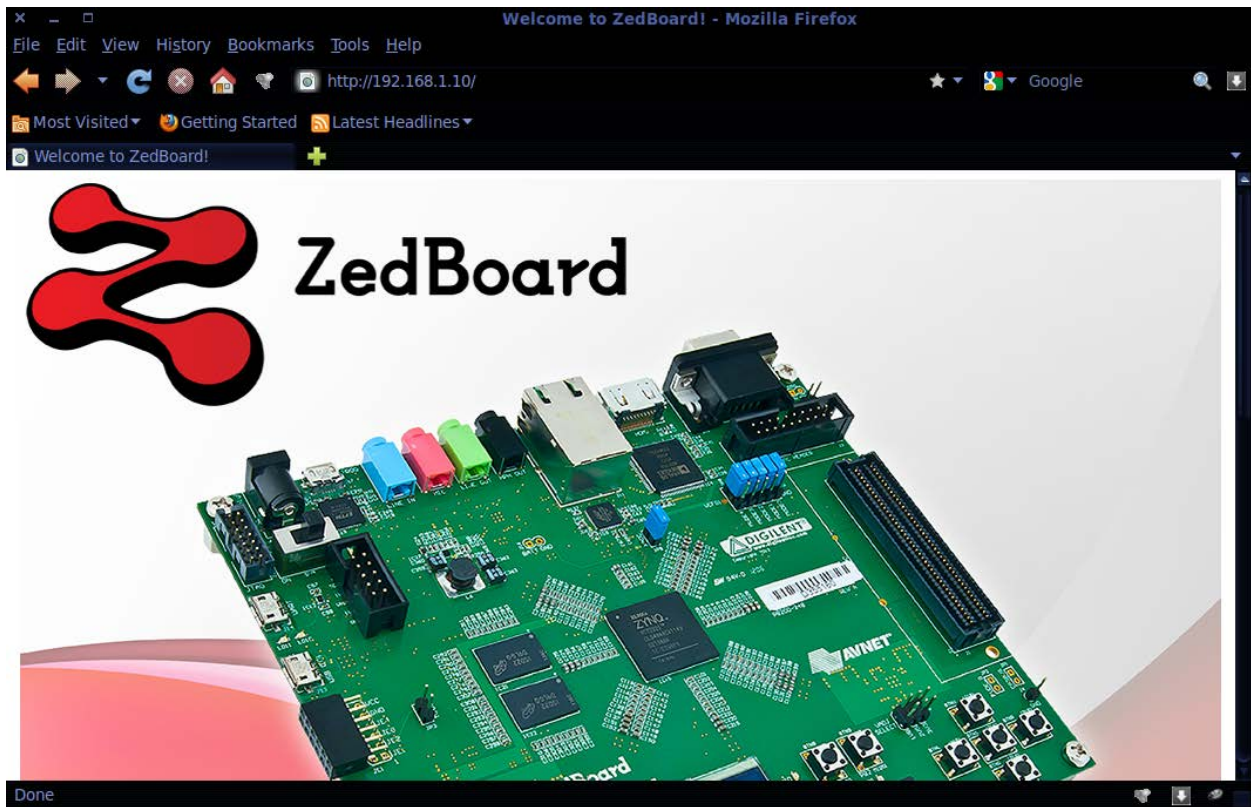

Figure 33 – ZedBoard Webpage Shown In Host Browser



Copyright © 2012, Avnet, Inc. All rights reserved. Published by Avnet Electronics Marketing, a group of Avnet, Inc. Avnet, Inc. disclaims any proprietary interest or right in any trademarks, service marks, logos, domain names, company names, brands, product names, or other form of intellectual property other than its own. AVNET and the AV logo are registered trademarks of Avnet, Inc.

**P/N: GS-AES-Z7EV-7Z020-G-V7**